



15kV HEAT SHRINKABLE CABLE ACCESSORIES

Content

Introduction 3

Terminations

For unarmoured cables

[with copper tape screen](#) 4

[with copper wire screen](#) 12

For armoured cables

[For steel tape armoured cables with copper tape screen](#) 20

[For steel wire armoured cables with copper tape screen](#) 28

Straight Joints

For unarmoured cables

[with copper tape screen](#) 36

[with copper wire screen](#) 40

For armoured cables

[For steel tape armoured cables with copper tape screen](#) 44

[For steel wire armoured cables with copper tape screen](#) 48

15kV Heat Shrinkable Cable Accessories

MELEC 15kV heat shrinkable cable accessories are suitable for 8.7/15(17.5)kV, insulated with XLPE polymeric cables. Kits cover a wide range of cable sizes and varying cable constructions.

These accessories can be equipped with either crimping or mechanical lugs and connectors. MELEC mechanical lugs and connectors can be easily installed by a socket spanner without the need of crimping tools. Besides, they can reduce stock requirement because of their wide span range.

Features

- Compact dimensions
- Reliable stress control
- Multi-layer waterproofing ensures sealing and insulating performance.
- Anti-tracking and weather resistant
- Excellent UV and corrosion resistance
- Superior electrical and mechanical properties
- 20 years of service life

Standard

IEC 60502-4:2010

Performance

Test	Requirements
AC and DC voltage	AC for 5min at 4.5 U_0 and DC for 15min at 4 U_0
AC (wet) (only for outdoor terminations)	1 min at 4 U_0
Partial discharge	10pC max. at 1.73 U_0
Impulse at θ_t	10 impulses of each polarity
Heating cycles in air	For terminations: 60 cycles at θ_t and 2.5 U_0 ; For joints: 30 cycles at θ_t and 2.5 U_0
Immersion test (only for outdoor terminations)	10 cycles at θ_t
Heating cycles under water (only for joints) □	30 cycles e at qt c, d and 2,5 U_0 , water height 1 m
Partial discharge at θ_t and ambient temperature	10pC max. at 1.73 U_0
Thermal short-circuit (screen)	Two short-circuits at I_{sc} of the cable screen. No visible deterioration.
Thermal short-circuit (conductor)	Two short-circuits to raise conductor to θ_{sc} of the cable. No visible deterioration.
Dynamic short-circuit	One short-circuit at I_d . No visible deterioration
Impulse	10 impulses of each polarity
AC voltage	15 min at 2.5 U_0
Humidity (only for indoor terminations)	300h at 1.25 U_0
Salt fog (only for outdoor terminations)	1000h at 1.25 U_0

* θ_t is the maximum cable conductor temperature in normal operation +5K to +10K;

θ_{sc} is maximum permissible short-circuit temperature of the cable conductor;

I_{sc} is short-circuit current (r.m.s. value) in the metallic screen;

I_d is short-circuit current (initial peak value) in the conductor.

15kV Heat Shrinkable Termination Accessories

Application

MZDN is an indoor kit suitable for 3-core, unarmoured cables with copper tape screen.

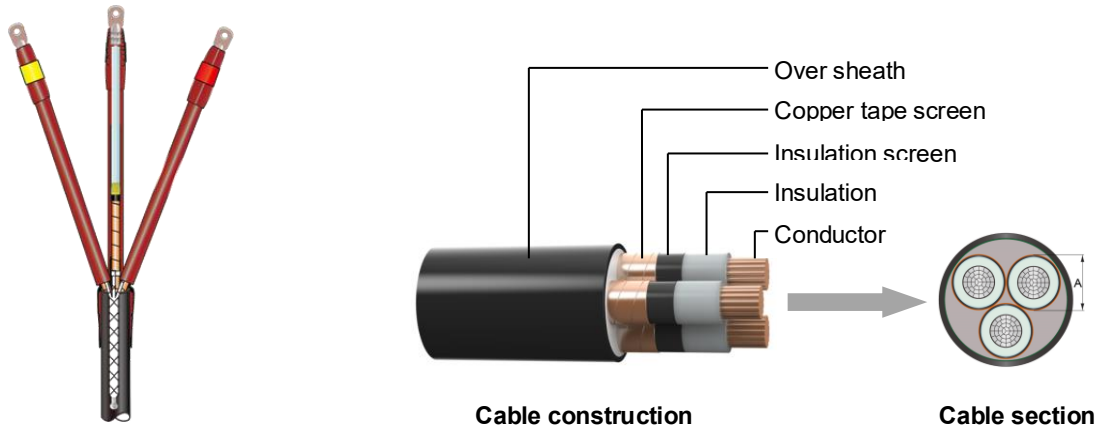

Cores	Type	Cross-section (mm ²)	Dia over Insulation A (mm)	Max. Dia over Lugs (mm)	Recommended Cable Lugs
 3-core	MZDN-3-15-A/01	25-95	18.5~23.7	25.0	AU AUS CAL-BS CAL-BG CXAU DTLL AUL
	MZDN-3-15-B/01	35-150	19.5~26.7	28.0	
	MZDN-3-15-C/01	70-240	22.1~30.5	34.5	
	MZDN-3-15-D/01	120-300	25.1~32.7	40.0	
	MZDN-3-15-E/01	185-400	28.3~35.6	42.0	
	MZDN-3-15-F/01	500-630	38.8~43.2	52.0	

Note: Please consult MELEC sales for more details about cable lugs.

Standard Package List

Items	Selection
-------	-----------

CABLE LUG	<input type="checkbox"/>
HEAT SHRINKABLE TRACK-RESISTANT TUBING(FOR SEALING)	<input checked="" type="checkbox"/>
STRESS CONTROL MASTIC(RHOMBUS)	<input checked="" type="checkbox"/>
SILICON GREASE	<input checked="" type="checkbox"/>
HEAT SHRINKABLE STRESS CONTROL TUBING	<input checked="" type="checkbox"/>
SEMI-CONDUCTIVE TAPE	<input checked="" type="checkbox"/>
COPPER BRAID	<input checked="" type="checkbox"/>
CONSTANT FORCE SPRING	<input checked="" type="checkbox"/>
COPPER LUG(FOR COPPER BRAID)	<input type="checkbox"/>
TRIANGULAR WEDGE	<input type="checkbox"/>
WATERPROOFING SEALING MASTIC	<input checked="" type="checkbox"/>
HEAT SHRINKABLE INSULATION BREAKOUT	<input checked="" type="checkbox"/>
HEAT SHRINKABLE TRACK-RESISTANT TUBING(FOR INSULATING)	<input checked="" type="checkbox"/>
PHASE TUBING	<input checked="" type="checkbox"/>
PVC TAPE	<input type="checkbox"/>
EMERY CLOTH(400 MESHES)	<input type="checkbox"/>
EMERY CLOTH(185 MESHES)	<input type="checkbox"/>
CLEANING KIT	<input type="checkbox"/>
CLEANING CLOTH	<input type="checkbox"/>
PE GLOVES	<input type="checkbox"/>
UNDERSHIRT CLOTH GLOVES	<input type="checkbox"/>
INSTALLATION INSTRUCTION	<input checked="" type="checkbox"/>
PACKAGE LIST	<input checked="" type="checkbox"/>

Note: ■ The marked items are basically required.
 MELEC also provides customized set. Just tick on for your needs.
 Please consult MELEC sales for more details.

15kV Heat Shrinkable Termination Accessories

Application

MZDW is an outdoor kit suitable for 3-core, unarmoured cables with copper tape screen.

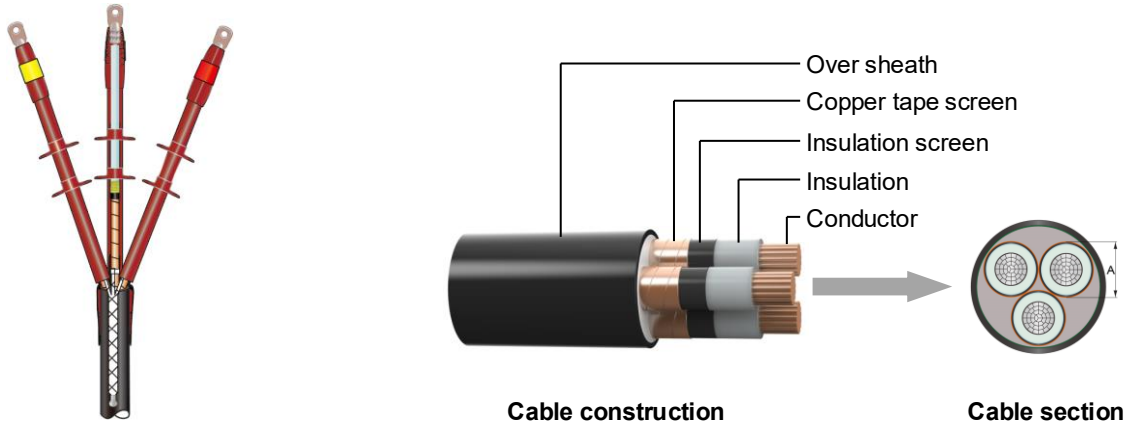

Cores	Type	Cross-section (mm ²)	Dia over Insulation A (mm)	Max. Dia over Lugs (mm)	Recommended Cable Lugs
 3-core	MZDW-3-15-A/01	25-95	18.5~23.7	25.0	AU AUS CAL-BS CAL-BG CXAU DTLL AUL
	MZDW-3-15-B/01	35-150	19.5~26.7	28.0	
	MZDW-3-15-C/01	70-240	22.1~30.5	34.5	
	MZDW-3-15-D/01	120-300	25.1~32.7	40.0	
	MZDW-3-15-E/01	185-400	28.3~35.6	42.0	
	MZDW-3-15-F/01	500-630	38.8~43.2	52.0	

Note: Please consult MELEC sales for more details about cable lugs.

Standard Package List

Items	Selection
CABLE LUG	<input type="checkbox"/>
HEAT SHRINKABLE TRACK-RESISTANT TUBING(FOR SEALING)	<input checked="" type="checkbox"/>
STRESS CONTROL MASTIC(RHOMBUS)	<input checked="" type="checkbox"/>
SILICON GREASE	<input checked="" type="checkbox"/>
HEAT SHRINKABLE STRESS CONTROL TUBING	<input checked="" type="checkbox"/>
SEMI-CONDUCTIVE TAPE	<input checked="" type="checkbox"/>
COPPER BRAID	<input checked="" type="checkbox"/>
CONSTANT FORCE SPRING	<input checked="" type="checkbox"/>
COPPER LUG(FOR COPPER BRAID)	<input type="checkbox"/>
TRIANGULAR WEDGE	<input type="checkbox"/>
WATERPROOFING SEALING MASTIC	<input checked="" type="checkbox"/>
HEAT SHRINKABLE INSULATION BREAKOUT	<input checked="" type="checkbox"/>
HEAT SHRINKABLE TRACK-RESISTANT TUBING(FOR INSULATING)	<input checked="" type="checkbox"/>
PHASE TUBING	<input checked="" type="checkbox"/>
HEAT SHRINKABLE SKIRT	<input checked="" type="checkbox"/>
PVC TAPE	<input type="checkbox"/>
EMERY CLOTH(400 MESHES)	<input type="checkbox"/>
EMERY CLOTH(185 MESHES)	<input type="checkbox"/>
CLEANING KIT	<input type="checkbox"/>
CLEANING CLOTH	<input type="checkbox"/>
PE GLOVES	<input type="checkbox"/>
UNDERSHIRT CLOTH GLOVES	<input type="checkbox"/>
INSTALLATION INSTRUCTION	<input checked="" type="checkbox"/>
PACKAGE LIST	<input checked="" type="checkbox"/>

Note: ■ The marked items are basically required.
 MELEC also provides customized set. Just tick on for your needs.
 Please consult MELEC sales for more details.

15kV Heat Shrinkable Termination Accessories

Application

MZDN is an indoor kit suitable for single core, unarmoured cables with copper tape screen.

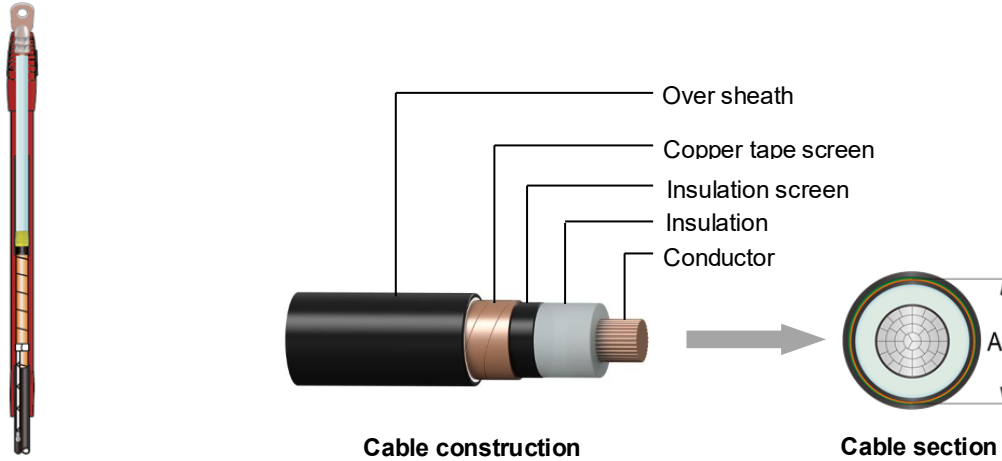

Cores	Type	Cross-section (mm ²)	Dia over Insulation A (mm)	Max. Dia over Lugs (mm)	Recommended Cable Lugs
 1-core	MZDN-1-15-A/01	25-95	18.5~23.7	25.0	AU AUS CAL-BS CAL-BG CXAU DTLL AUL
	MZDN-1-15-B/01	35-150	19.5~26.7	28.0	
	MZDN-1-15-C/01	70-240	22.1~30.5	34.5	
	MZDN-1-15-D/01	120-300	25.1~32.7	40.0	
	MZDN-1-15-E/01	185-400	28.3~35.6	42.0	
	MZDN-1-15-F/01	500-630	38.8~43.2	52.0	

Note: Please consult MELEC sales for more details about cable lugs.

Standard Package List

Items	Selection
-------	-----------

CABLE LUG	<input type="checkbox"/>
HEAT SHRINKABLE TRACK-RESISTANT TUBING(FOR SEALING)	<input checked="" type="checkbox"/>
STRESS CONTROL MASTIC(RHOMBUS)	<input checked="" type="checkbox"/>
SILICON GREASE	<input checked="" type="checkbox"/>
HEAT SHRINKABLE STRESS CONTROL TUBING	<input checked="" type="checkbox"/>
SEMI-CONDUCTIVE TAPE	<input checked="" type="checkbox"/>
COPPER BRAID	<input checked="" type="checkbox"/>
COPPER LUG(FOR COPPER BRAID)	<input type="checkbox"/>
CONSTANT FORCE SPRING	<input checked="" type="checkbox"/>
WATERPROOFING SEALING MASTIC	<input checked="" type="checkbox"/>
HEAT SHRINKABLE TRACK-RESISTANT TUBING(FOR INSULATING)	<input checked="" type="checkbox"/>
PVC TAPE	<input type="checkbox"/>
EMERY CLOTH(400 MESHES)	<input type="checkbox"/>
EMERY CLOTH(185 MESHES)	<input type="checkbox"/>
CLEANING KIT	<input type="checkbox"/>
CLEANING CLOTH	<input type="checkbox"/>
PE GLOVES	<input type="checkbox"/>
UNDERSHIRT CLOTH GLOVES	<input type="checkbox"/>
INSTALLATION INSTRUCTION	<input checked="" type="checkbox"/>
PACKAGE LIST	<input checked="" type="checkbox"/>

Note: ■ The marked items are basically required.

MELEC also provides customized set. Just tick on for your needs.
Please consult MELEC sales for more details.

15kV Heat Shrinkable Termination Accessories

Application

MZDW is an outdoor kit suitable for single core, unarmoured cables with copper tape screen.

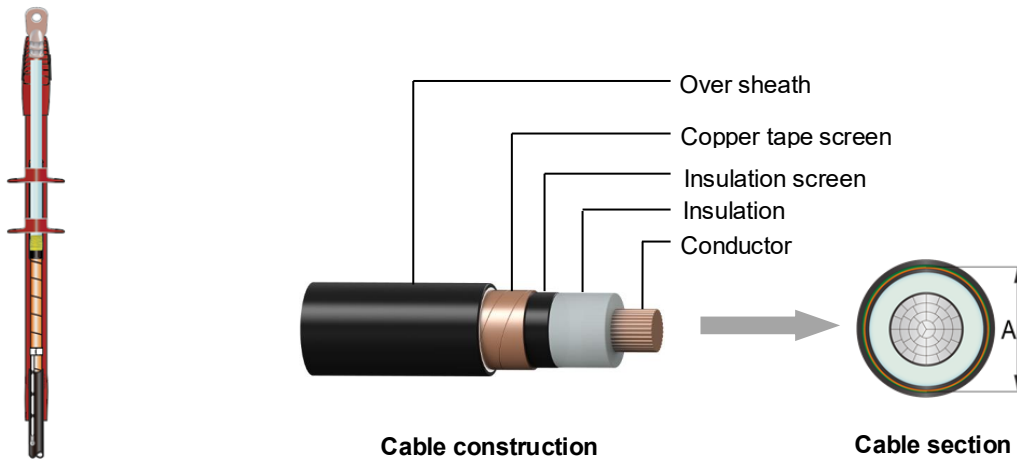

Cores	Type	Cross-section (mm ²)	Dia over Insulation A (mm)	Max. Dia over Lugs (mm)	Recommended Cable Lugs
 1-core	MZDW-1-15-A/01	25-95	18.5~23.7	25.0	AU AUS CAL-BS CAL-BG CXAU DTLL AUL
	MZDW-1-15-B/01	35-150	19.5~26.7	28.0	
	MZDW-1-15-C/01	70-240	22.1~30.5	34.5	
	MZDW-1-15-D/01	120-300	25.1~32.7	40.0	
	MZDW-1-15-E/01	185-400	28.3~35.6	42.0	
	MZDW-1-15-F/01	500-630	38.8~43.2	52.0	

Note: Please consult MELEC sales for more details about cable lugs.

Standard Package List

Items	Selection
CABLE LUG	<input type="checkbox"/>
HEAT SHRINKABLE TRACK-RESISTANT TUBING(FOR SEALING)	<input checked="" type="checkbox"/>
STRESS CONTROL MASTIC(RHOMBUS)	<input checked="" type="checkbox"/>
SILICON GREASE	<input checked="" type="checkbox"/>
HEAT SHRINKABLE STRESS CONTROL TUBING	<input checked="" type="checkbox"/>
SEMI-CONDUCTIVE TAPE	<input checked="" type="checkbox"/>
COPPER BRAID	<input checked="" type="checkbox"/>
COPPER LUG(FOR COPPER BRAID)	<input type="checkbox"/>
CONSTANT FORCE SPRING	<input checked="" type="checkbox"/>
WATERPROOFING SEALING MASTIC	<input checked="" type="checkbox"/>
HEAT SHRINKABLE TRACK-RESISTANT TUBING(FOR INSULATING)	<input checked="" type="checkbox"/>
HEAT SHRINKABLE SKIRT	<input checked="" type="checkbox"/>
PVC TAPE	<input type="checkbox"/>
EMERY CLOTH(400 MESHES)	<input type="checkbox"/>
EMERY CLOTH(185 MESHES)	<input type="checkbox"/>
CLEANING KIT	<input type="checkbox"/>
CLEANING CLOTH	<input type="checkbox"/>
PE GLOVES	<input type="checkbox"/>
UNDERSHIRT CLOTH GLOVES	<input type="checkbox"/>
INSTALLATION INSTRUCTION	<input checked="" type="checkbox"/>
PACKAGE LIST	<input checked="" type="checkbox"/>

Note: ■ The marked items are basically required.
 MELEC also provides customized set. Just tick on for your needs.
 Please consult MELEC sales for more details.

15kV Heat Shrinkable Termination Accessories

Application

MZDN is an indoor kit suitable for 3-core, unarmoured cables with copper wire screen.

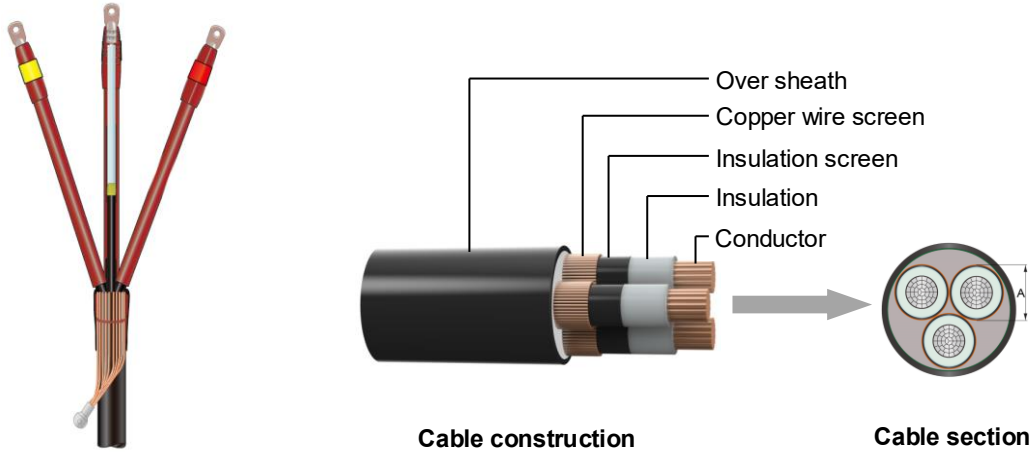

Cores	Type	Cross-section (mm ²)	Dia over Insulation A (mm)	Max. Dia over Lugs (mm)	Recommended Cable Lugs
 3-core	MZDN-3-15-A/02	25-95	18.5~23.7	25.0	AU AUS CAL-BS CAL-BG CXAU DTLL AUL
	MZDN-3-15-B/02	35-150	19.5~26.7	28.0	
	MZDN-3-15-C/02	70-240	22.1~30.5	34.5	
	MZDN-3-15-D/02	120-300	25.1~32.7	40.0	
	MZDN-3-15-E/02	185-400	28.3~35.6	42.0	
	MZDN-3-15-F/02	500-630	38.8~43.2	52.0	

Note: Please consult MELEC sales for more details about cable lugs.

Standard Package List

Items	Selection
CABLE LUG	<input type="checkbox"/>
HEAT SHRINKABLE TRACK-RESISTANT TUBING(FOR SEALING)	<input checked="" type="checkbox"/>
STRESS CONTROL MASTIC(RHOMBUS)	<input checked="" type="checkbox"/>
SILICON GREASE	<input checked="" type="checkbox"/>
HEAT SHRINKABLE STRESS CONTROL TUBING	<input checked="" type="checkbox"/>
COPPER BINDING-WIRE	<input checked="" type="checkbox"/>
COPPER LUG(FOR COPPER WIRE SCREEN)	<input checked="" type="checkbox"/>
TRIANGULAR WEDGE	<input type="checkbox"/>
WATERPROOFING SEALING MASTIC	<input checked="" type="checkbox"/>
HEAT SHRINKABLE INSULATION BREAKOUT	<input checked="" type="checkbox"/>
HEAT SHRINKABLE TRACK-RESISTANT TUBING(FOR INSULATING)	<input checked="" type="checkbox"/>
PHASE TUBING	<input checked="" type="checkbox"/>
PVC TAPE	<input type="checkbox"/>
EMERY CLOTH(400 MESHES)	<input type="checkbox"/>
EMERY CLOTH(185 MESHES)	<input type="checkbox"/>
CLEANING KIT	<input type="checkbox"/>
CLEANING CLOTH	<input type="checkbox"/>
PE GLOVES	<input type="checkbox"/>
UNDERSHIRT CLOTH GLOVES	<input type="checkbox"/>
INSTALLATION INSTRUCTION	<input checked="" type="checkbox"/>
PACKAGE LIST	<input checked="" type="checkbox"/>

Note: ■ The marked items are basically required.

- MELEC also provides customized set. Just tick on for your needs.
Please consult MELEC sales for more details.

15kV Heat Shrinkable Termination Accessories

Application

MZDW is an outdoor kit suitable for 3-core, unarmoured cables with copper wire screen.

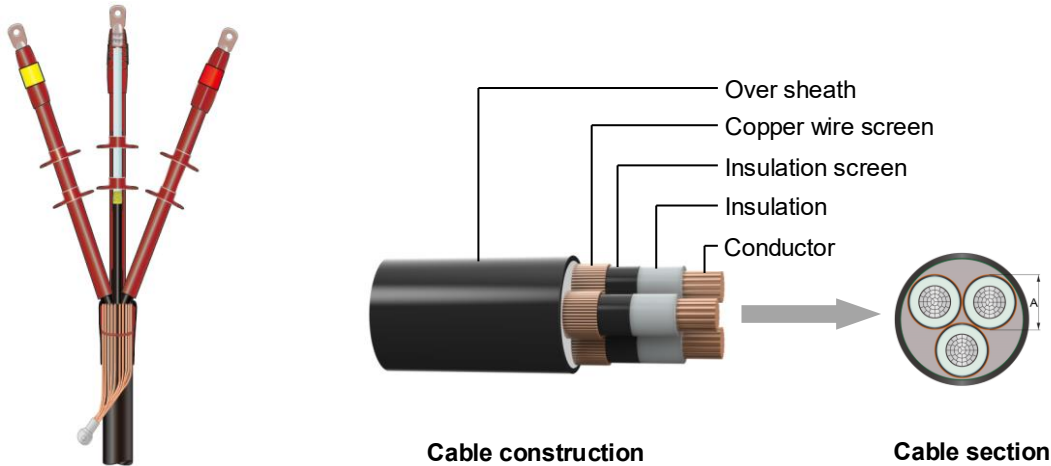

Cores	Type	Cross-section (mm ²)	Dia over Insulation A (mm)	Max. Dia over Lugs (mm)	Recommended Cable Lugs
 3-core	MZDW-3-15-A/02	25-95	18.5~23.7	25.0	AU AUS CAL-BS CAL-BG CXAU DTLL AUL
	MZDW-3-15-B/02	35-150	19.5~26.7	28.0	
	MZDW-3-15-C/02	70-240	22.1~30.5	34.5	
	MZDW-3-15-D/02	120-300	25.1~32.7	40.0	
	MZDW-3-15-E/02	185-400	28.3~35.6	42.0	
	MZDW-3-15-F/02	500-630	38.8~43.2	52.0	

Note: Please consult MELEC sales for more details about cable lugs.

Standard Package List

Items	Selection
CABLE LUG	<input type="checkbox"/>
HEAT SHRINKABLE TRACK-RESISTANT TUBING(FOR SEALING)	<input checked="" type="checkbox"/>
STRESS CONTROL MASTIC(RHOMBUS)	<input checked="" type="checkbox"/>
SILICON GREASE	<input checked="" type="checkbox"/>
HEAT SHRINKABLE STRESS CONTROL TUBING	<input checked="" type="checkbox"/>
COPPER BINDING-WIRE	<input checked="" type="checkbox"/>
COPPER LUG(FOR COPPER WIRE SCREEN)	<input checked="" type="checkbox"/>
TRIANGULAR WEDGE	<input type="checkbox"/>
WATERPROOFING SEALING MASTIC	<input checked="" type="checkbox"/>
HEAT SHRINKABLE INSULATION BREAKOUT	<input checked="" type="checkbox"/>
HEAT SHRINKABLE TRACK-RESISTANT TUBING(FOR INSULATING)	<input checked="" type="checkbox"/>
PHASE TUBING	<input checked="" type="checkbox"/>
HEAT SHRINKABLE SKIRT	<input checked="" type="checkbox"/>
PVC TAPE	<input type="checkbox"/>
EMERY CLOTH(400 MESHES)	<input type="checkbox"/>
EMERY CLOTH(185 MESHES)	<input type="checkbox"/>
CLEANING KIT	<input type="checkbox"/>
CLEANING CLOTH	<input type="checkbox"/>
PE GLOVES	<input type="checkbox"/>
UNDERSHIRT CLOTH GLOVES	<input type="checkbox"/>
INSTALLATION INSTRUCTION	<input checked="" type="checkbox"/>
PACKAGE LIST	<input checked="" type="checkbox"/>

Note: ■ The marked items are basically required.
 MELEC also provides customized set. Just tick on for your needs.
 Please consult MELEC sales for more details.

15kV Heat Shrinkable Termination Accessories

Application

MZDN is an indoor kit suitable for single core, unarmoured cables with copper wire screen.

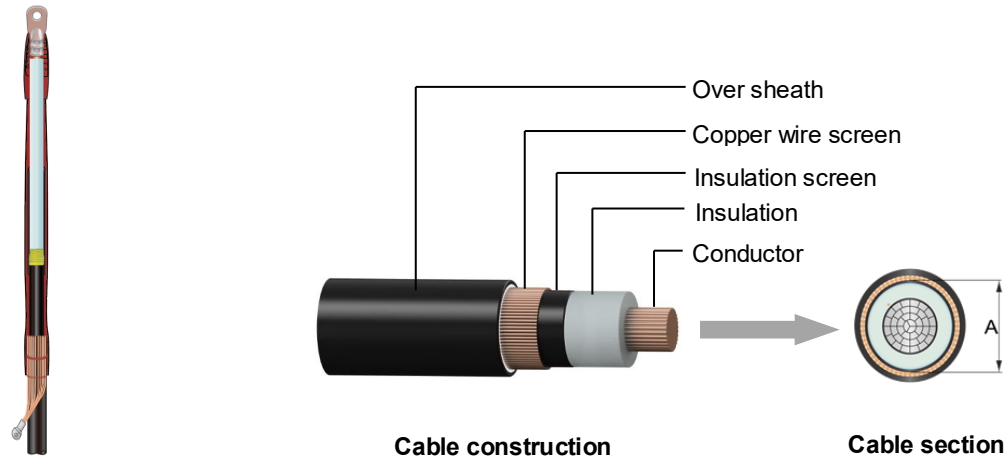

Cores	Type	Cross-section (mm ²)	Dia over Insulation A (mm)	Max. Dia over Lugs (mm)	Recommended Cable Lugs
 1-core	MZDN-1-15-A/02	25-95	18.5~23.7	25.0	AU AUS CAL-BS CAL-BG CXAU DTLL AUL
	MZDN-1-15-B/02	35-150	19.5~26.7	28.0	
	MZDN-1-15-C/02	70-240	22.1~30.5	34.5	
	MZDN-1-15-D/02	120-300	25.1~32.7	40.0	
	MZDN-1-15-E/02	185-400	28.3~35.6	42.0	
	MZDN-1-15-F/02	500-630	38.8~43.2	52.0	

Note: Please consult MELEC sales for more details about cable lugs.

Standard Package List

Items	Selection
CABLE LUG	<input type="checkbox"/>
HEAT SHRINKABLE TRACK-RESISTANT TUBING(FOR SEALING)	<input checked="" type="checkbox"/>
STRESS CONTROL MASTIC(RHOMBUS)	<input checked="" type="checkbox"/>
SILICON GREASE	<input checked="" type="checkbox"/>
HEAT SHRINKABLE STRESS CONTROL TUBING	<input checked="" type="checkbox"/>
COPPER BINDING-WIRE	<input checked="" type="checkbox"/>
COPPER LUG(FOR COPPER WIRE SCREEN)	<input checked="" type="checkbox"/>
WATERPROOFING SEALING MASTIC	<input checked="" type="checkbox"/>
HEAT SHRINKABLE TRACK-RESISTANT TUBING(FOR INSULATING)	<input checked="" type="checkbox"/>
PVC TAPE	<input type="checkbox"/>
EMERY CLOTH(400 MESHES)	<input type="checkbox"/>
EMERY CLOTH(185 MESHES)	<input type="checkbox"/>
CLEANING KIT	<input type="checkbox"/>
CLEANING CLOTH	<input type="checkbox"/>
PE GLOVES	<input type="checkbox"/>
UNDERSHIRT CLOTH GLOVES	<input type="checkbox"/>
INSTALLATION INSTRUCTION	<input checked="" type="checkbox"/>
PACKAGE LIST	<input checked="" type="checkbox"/>

Note: ■ The marked items are basically required.
 MELEC also provides customized set. Just tick on for your needs.
 Please consult MELEC sales for more details.

15kV Heat Shrinkable Termination Accessories

Application

MZDW is an outdoor kit suitable for single core, unarmoured cables with copper wire screen.

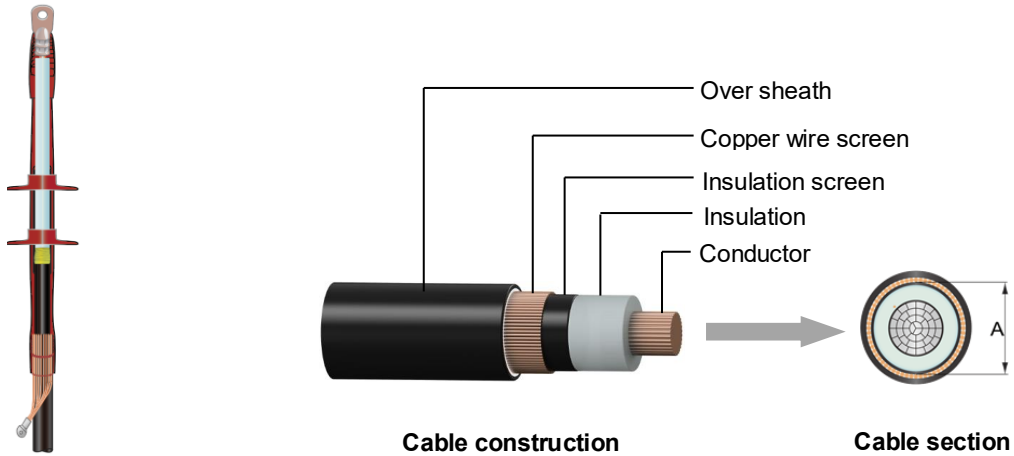

Cores	Type	Cross-section (mm ²)	Dia over Insulation A (mm)	Max. Dia over Lugs (mm)	Recommended Cable Lugs
 1-core	MZDW-1-15-A/02	25-95	18.5~23.7	25.0	AU AUS CAL-BS CAL-BG CXAU DTLL AUL
	MZDW-1-15-B/02	35-150	19.5~26.7	28.0	
	MZDW-1-15-C/02	70-240	22.1~30.5	34.5	
	MZDW-1-15-D/02	120-300	25.1~32.7	40.0	
	MZDW-1-15-E/02	185-400	28.3~35.6	42.0	
	MZDW-1-15-F/02	500-630	38.8~43.2	52.0	

Note: Please consult MELEC sales for more details about cable lugs.

Standard Package List

Items	Selection
CABLE LUG	<input type="checkbox"/>
HEAT SHRINKABLE TRACK-RESISTANT TUBING(FOR SEALING)	<input checked="" type="checkbox"/>
STRESS CONTROL MASTIC(RHOMBUS)	<input checked="" type="checkbox"/>
SILICON GREASE	<input checked="" type="checkbox"/>
HEAT SHRINKABLE STRESS CONTROL TUBING	<input checked="" type="checkbox"/>
COPPER BINDING-WIRE	<input checked="" type="checkbox"/>
COPPER LUG(FOR COPPER WIRE SCREEN)	<input checked="" type="checkbox"/>
WATERPROOFING SEALING MASTIC	<input checked="" type="checkbox"/>
HEAT SHRINKABLE TRACK-RESISTANT TUBING(FOR INSULATING)	<input checked="" type="checkbox"/>
HEAT SHRINKABLE SKIRT	<input checked="" type="checkbox"/>
PVC TAPE	<input type="checkbox"/>
EMERY CLOTH(400 MESHES)	<input type="checkbox"/>
EMERY CLOTH(185 MESHES)	<input type="checkbox"/>
CLEANING KIT	<input type="checkbox"/>
CLEANING CLOTH	<input type="checkbox"/>
PE GLOVES	<input type="checkbox"/>
UNDERSHIRT CLOTH GLOVES	<input type="checkbox"/>
INSTALLATION INSTRUCTION	<input checked="" type="checkbox"/>
PACKAGE LIST	<input checked="" type="checkbox"/>

Note: ■ The marked items are basically required.
 MELEC also provides customized set. Just tick on for your needs.
 Please consult MELEC sales for more details.

15kV Heat Shrinkable Termination Accessories

Application

MZDNK is an indoor kit suitable for 3-core, steel tape armoured cables with copper tape screen.

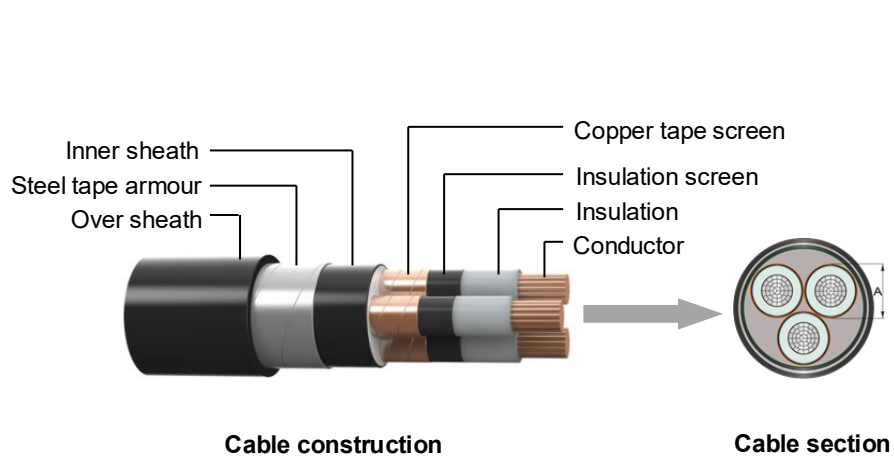

Cores	Type	Cross-section (mm ²)	Dia over Insulation A (mm)	Max. Dia over Lugs (mm)	Recommended Cable Lugs
 3-core	MZDNK-3-15-A/11	25-95	18.5~23.7	25.0	AU AUS CAL-BS CAL-BG CXAU DTLL AUL
	MZDNK-3-15-B/11	35-150	19.5~26.7	28.0	
	MZDNK-3-15-C/11	70-240	22.1~30.5	34.5	
	MZDNK-3-15-D/11	120-300	25.1~32.7	40.0	
	MZDNK-3-15-E/11	185-400	28.3~35.6	42.0	
	MZDNK-3-15-F/11	500-630	38.8~43.2	52.0	

Note: Please consult MELEC sales for more details about cable lugs.

Standard Package List

Items	Selection
CABLE LUG	<input type="checkbox"/>
HEAT SHRINKABLE TRACK-RESISTANT TUBING(FOR SEALING)	<input checked="" type="checkbox"/>
STRESS CONTROL MASTIC(RHOMBUS)	<input checked="" type="checkbox"/>
SILICON GREASE	<input checked="" type="checkbox"/>
HEAT SHRINKABLE STRESS CONTROL TUBING	<input checked="" type="checkbox"/>
SEMI-CONDUCTIVE TAPE	<input checked="" type="checkbox"/>
COPPER BRAID(FOR SCREEN)	<input checked="" type="checkbox"/>
CONSTANT FORCE SPRING(FOR SCREEN)	<input checked="" type="checkbox"/>
COPPER LUG(FOR COPPER BRAID)	<input type="checkbox"/>
TRIANGULAR WEDGE	<input type="checkbox"/>
COPPER BINDING-WIRE	<input checked="" type="checkbox"/>
COPPER BRAID(FOR ARMOUR)	<input checked="" type="checkbox"/>
CONSTANT FORCE SPRING(FOR ARMOUR)	<input checked="" type="checkbox"/>
FILLING MASTIC	<input checked="" type="checkbox"/>
HEAT SHRINKABLE TUBING	<input checked="" type="checkbox"/>
WATERPROOFING SEALING MASTIC	<input checked="" type="checkbox"/>
HEAT SHRINKABLE INSULATION BREAKOUT	<input checked="" type="checkbox"/>
HEAT SHRINKABLE TRACK-RESISTANT TUBING(FOR INSULATING)	<input checked="" type="checkbox"/>
PHASE TUBING	<input checked="" type="checkbox"/>
PVC TAPE	<input type="checkbox"/>
EMERY CLOTH(400 MESHES)	<input type="checkbox"/>
EMERY CLOTH(185 MESHES)	<input type="checkbox"/>
CLEANING KIT	<input type="checkbox"/>
CLEANING CLOTH	<input type="checkbox"/>
PE GLOVES	<input type="checkbox"/>
UNDERSHIRT CLOTH GLOVES	<input type="checkbox"/>
INSTALLATION INSTRUCTION	<input checked="" type="checkbox"/>
PACKAGE LIST	<input checked="" type="checkbox"/>

Note: ■ The marked items are basically required.
 MELEC also provides customized set. Just tick on for your needs.
 Please consult MELEC sales for more details.

15kV Heat Shrinkable Termination Accessories

Application

MZDWK is an outdoor kit suitable for 3-core, steel tape armoured cables with copper tape screen.

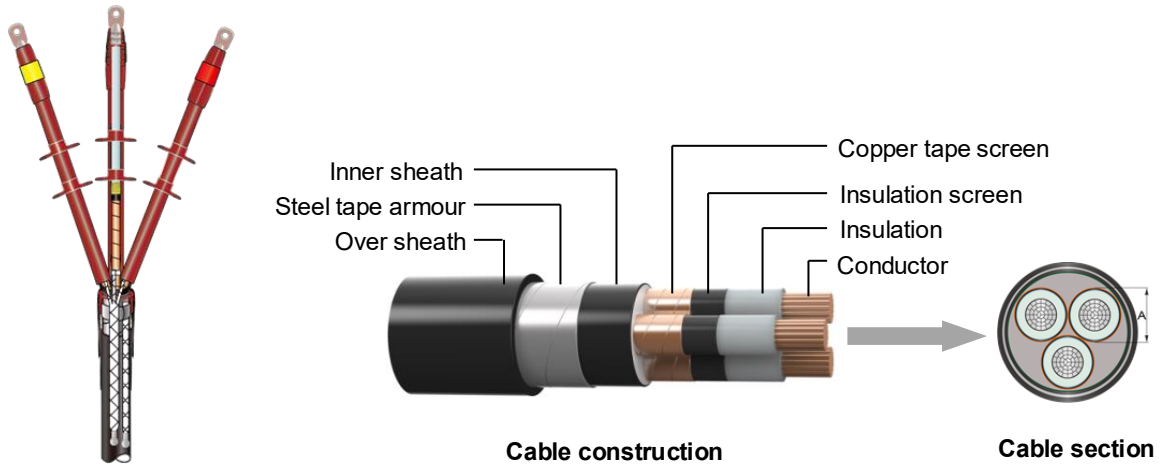

Cores	Type	Cross-section (mm ²)	Dia over Insulation A (mm)	Max. Dia over Lugs (mm)	Recommended Cable Lugs
 3-core	MZDWK-3-15-A/11	25-95	18.5~23.7	25.0	AU AUS CAL-BS CAL-BG CXAU DTL AUL
	MZDWK-3-15-B/11	35-150	19.5~26.7	28.0	
	MZDWK-3-15-C/11	70-240	22.1~30.5	34.5	
	MZDWK-3-15-D/11	120-300	25.1~32.7	40.0	
	MZDWK-3-15-E/11	185-400	28.3~35.6	42.0	
	MZDWK-3-15-F/11	500-630	38.8~43.2	52.0	

Note: Please consult MELEC sales for more details about cable lugs.

Standard Package List

Items	Selection
CABLE LUG	<input type="checkbox"/>
HEAT SHRINKABLE TRACK-RESISTANT TUBING(FOR SEALING)	<input checked="" type="checkbox"/>
STRESS CONTROL MASTIC(RHOMBUS)	<input checked="" type="checkbox"/>
SILICON GREASE	<input checked="" type="checkbox"/>
HEAT SHRINKABLE STRESS CONTROL TUBING	<input checked="" type="checkbox"/>
SEMI-CONDUCTIVE TAPE	<input checked="" type="checkbox"/>
COPPER BRAID(FOR SCREEN)	<input checked="" type="checkbox"/>
CONSTANT FORCE SPRING(FOR SCREEN)	<input checked="" type="checkbox"/>
COPPER LUG(FOR COPPER BRAID)	<input type="checkbox"/>
TRIANGULAR WEDGE	<input type="checkbox"/>
COPPER BINDING-WIRE	<input checked="" type="checkbox"/>
COPPER BRAID(FOR ARMOUR)	<input checked="" type="checkbox"/>
CONSTANT FORCE SPRING(FOR ARMOUR)	<input checked="" type="checkbox"/>
FILLING MASTIC	<input checked="" type="checkbox"/>
HEAT SHRINKABLE TUBING	<input checked="" type="checkbox"/>
WATERPROOFING SEALING MASTIC	<input checked="" type="checkbox"/>
HEAT SHRINKABLE INSULATION BREAKOUT	<input checked="" type="checkbox"/>
HEAT SHRINKABLE TRACK-RESISTANT TUBING(FOR INSULATING)	<input checked="" type="checkbox"/>
PHASE TUBING	<input checked="" type="checkbox"/>
HEAT SHRINKABLE SKIRT	<input checked="" type="checkbox"/>
PVC TAPE	<input type="checkbox"/>
EMERY CLOTH(400 MESHES)	<input type="checkbox"/>
EMERY CLOTH(185 MESHES)	<input type="checkbox"/>
CLEANING KIT	<input type="checkbox"/>
CLEANING CLOTH	<input type="checkbox"/>
PE GLOVES	<input type="checkbox"/>
UNDERSHIRT CLOTH GLOVES	<input type="checkbox"/>
INSTALLATION INSTRUCTION	<input checked="" type="checkbox"/>
PACKAGE LIST	<input checked="" type="checkbox"/>

Note: ■ The marked items are basically required.
 MELEC also provides customized set. Just tick on for your needs.
 Please consult MELEC sales for more details.

15kV Heat Shrinkable Termination Accessories

Application

MZDNK is an indoor kit suitable for single core, steel tape armoured cables with copper tape screen.

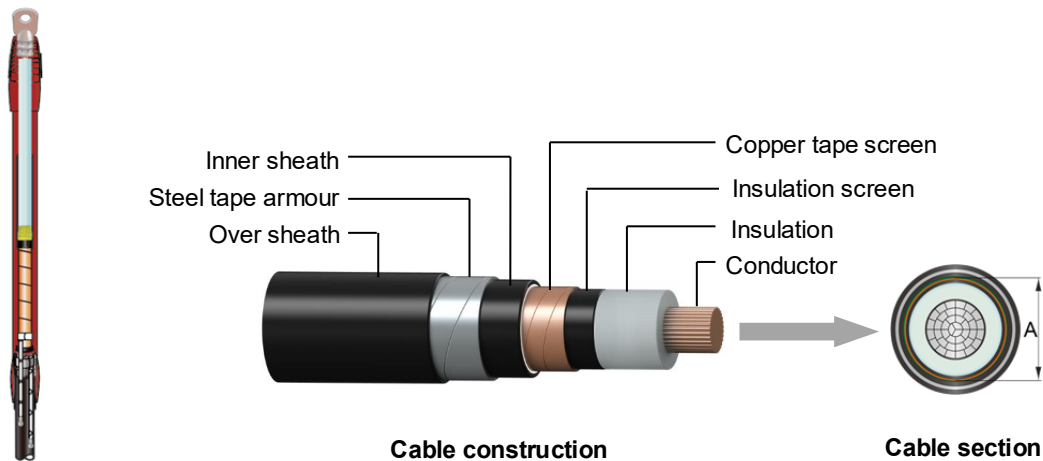

Cores	Type	Cross-section (mm ²)	Dia over Insulation A (mm)	Max. Dia over Lugs (mm)	Recommended Cable Lugs
 1-core	MZDNK-1-15-A/11	25-95	18.5~23.7	25.0	AU AUS CAL-BS CAL-BG CXAU DTLL AUL
	MZDNK-1-15-B/11	35-150	19.5~26.7	28.0	
	MZDNK-1-15-C/11	70-240	22.1~30.5	34.5	
	MZDNK-1-15-D/11	120-300	25.1~32.7	40.0	
	MZDNK-1-15-E/11	185-400	28.3~35.6	42.0	
	MZDNK-1-15-F/11	500-630	38.8~43.2	52.0	

Note: Please consult MELEC sales for more details about cable lugs.

Standard Package List

Items	Selection
CABLE LUG	<input type="checkbox"/>
HEAT SHRINKABLE TRACK-RESISTANT TUBING(FOR SEALING)	<input checked="" type="checkbox"/>
STRESS CONTROL MASTIC(RHOMBUS)	<input checked="" type="checkbox"/>
SILICON GREASE	<input checked="" type="checkbox"/>
HEAT SHRINKABLE STRESS CONTROL TUBING	<input checked="" type="checkbox"/>
SEMI-CONDUCTIVE TAPE	<input checked="" type="checkbox"/>
COPPER BRAID(FOR SCREEN)	<input checked="" type="checkbox"/>
COPPER LUG(FOR COPPER BRAID)	<input type="checkbox"/>
CONSTANT FORCE SPRING(FOR SCREEN)	<input checked="" type="checkbox"/>
COPPER BINDING-WIRE	<input checked="" type="checkbox"/>
COPPER BRAID(FOR ARMOUR)	<input checked="" type="checkbox"/>
CONSTANT FORCE SPRING(FOR ARMOUR)	<input checked="" type="checkbox"/>
FILLING MASTIC	<input checked="" type="checkbox"/>
HEAT SHRINKABLE TUBING	<input checked="" type="checkbox"/>
WATERPROOFING SEALING MASTIC	<input checked="" type="checkbox"/>
HEAT SHRINKABLE TRACK-RESISTANT TUBING(FOR INSULATING)	<input checked="" type="checkbox"/>
PVC TAPE	<input type="checkbox"/>
EMERY CLOTH(400 MESHES)	<input type="checkbox"/>
EMERY CLOTH(185 MESHES)	<input type="checkbox"/>
CLEANING KIT	<input type="checkbox"/>
CLEANING CLOTH	<input type="checkbox"/>
PE GLOVES	<input type="checkbox"/>
UNDERSHIRT CLOTH GLOVES	<input type="checkbox"/>
INSTALLATION INSTRUCTION	<input checked="" type="checkbox"/>
PACKAGE LIST	<input checked="" type="checkbox"/>

Note: ■ The marked items are basically required.
 MELEC also provides customized set. Just tick on for your needs.
 Please consult MELEC sales for more details.

15kV Heat Shrinkable Termination Accessories

Application

MZDWK is an outdoor kit suitable for single core, steel tape armoured cables with copper tape screen.

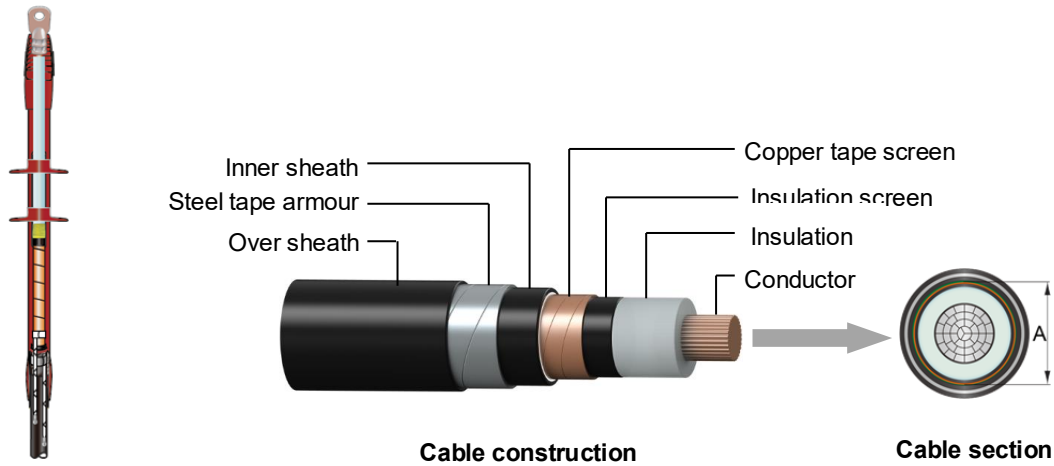

Cores	Type	Cross-section (mm ²)	Dia over Insulation A (mm)	Max. Dia over Lugs (mm)	Recommended Cable Lugs
 1-core	MZDWK-1-15-A/11	25-95	18.5~23.7	25.0	AU AUS CAL-BS CAL-BG CXAU DTLL AUL
	MZDWK-1-15-B/11	35-150	19.5~26.7	28.0	
	MZDWK-1-15-C/11	70-240	22.1~30.5	34.5	
	MZDWK-1-15-D/11	120-300	25.1~32.7	40.0	
	MZDWK-1-15-E/11	185-400	28.3~35.6	42.0	
	MZDWK-1-15-F/11	500-630	38.8~43.2	52.0	

Note: Please consult MELEC sales for more details about cable lugs.

Standard Package List

Items	Selection
CABLE LUG	<input type="checkbox"/>
HEAT SHRINKABLE TRACK-RESISTANT TUBING(FOR SEALING)	<input checked="" type="checkbox"/>
STRESS CONTROL MASTIC(RHOMBUS)	<input checked="" type="checkbox"/>
SILICON GREASE	<input checked="" type="checkbox"/>
HEAT SHRINKABLE STRESS CONTROL TUBING	<input checked="" type="checkbox"/>
SEMI-CONDUCTIVE TAPE	<input checked="" type="checkbox"/>
COPPER BRAID(FOR SCREEN)	<input checked="" type="checkbox"/>
COPPER LUG(FOR COPPER BRAID)	<input type="checkbox"/>
CONSTANT FORCE SPRING(FOR SCREEN)	<input checked="" type="checkbox"/>
COPPER BINDING-WIRE	<input checked="" type="checkbox"/>
COPPER BRAID(FOR ARMOUR)	<input checked="" type="checkbox"/>
CONSTANT FORCE SPRING(FOR ARMOUR)	<input checked="" type="checkbox"/>
FILLING MASTIC	<input checked="" type="checkbox"/>
HEAT SHRINKABLE TUBING	<input checked="" type="checkbox"/>
WATERPROOFING SEALING MASTIC	<input checked="" type="checkbox"/>
HEAT SHRINKABLE TRACK-RESISTANT TUBING(FOR INSULATING)	<input checked="" type="checkbox"/>
HEAT SHRINKABLE SKIRT	<input checked="" type="checkbox"/>
PVC TAPE	<input type="checkbox"/>
EMERY CLOTH(400 MESHES)	<input type="checkbox"/>
EMERY CLOTH(185 MESHES)	<input type="checkbox"/>
CLEANING KIT	<input type="checkbox"/>
CLEANING CLOTH	<input type="checkbox"/>
PE GLOVES	<input type="checkbox"/>
UNDERSHIRT CLOTH GLOVES	<input type="checkbox"/>
INSTALLATION INSTRUCTION	<input checked="" type="checkbox"/>
PACKAGE LIST	<input checked="" type="checkbox"/>

Note: ■ The marked items are basically required.
 MELEC also provides customized set. Just tick on for your needs.
 Please consult MELEC sales for more details.

15kV Heat Shrinkable Termination Accessories

Application

MZDNK is an indoor kit suitable for 3-core, steel wire armoured cables with copper tape screen.

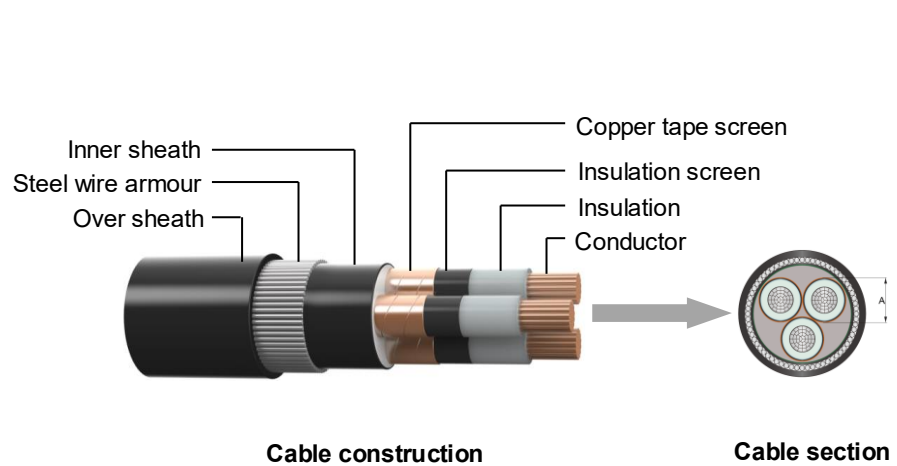

Cores	Type	Cross-section (mm ²)	Dia over Insulation A (mm)	Max. Dia over Lugs (mm)	Recommended Cable Lugs
 3-core	MZDNK-3-15-A/21	25-95	18.5~23.7	25.0	AU AUS CAL-BS CAL-BG CXAU DTLL AUL
	MZDNK-3-15-B/21	35-150	19.5~26.7	28.0	
	MZDNK-3-15-C/21	70-240	22.1~30.5	34.5	
	MZDNK-3-15-D/21	120-300	25.1~32.7	40.0	
	MZDNK-3-15-E/21	185-400	28.3~35.6	42.0	
	MZDNK-3-15-F/21	500-630	38.8~43.2	52.0	

Note: Please consult MELEC sales for more details about cable lugs.

Standard Package List

Items	Selection
CABLE LUG	<input type="checkbox"/>
HEAT SHRINKABLE TRACK-RESISTANT TUBING(FOR SEALING)	<input checked="" type="checkbox"/>
STRESS CONTROL MASTIC(RHOMBUS)	<input checked="" type="checkbox"/>
SILICON GREASE	<input checked="" type="checkbox"/>
HEAT SHRINKABLE STRESS CONTROL TUBING	<input checked="" type="checkbox"/>
SEMI-CONDUCTIVE TAPE	<input checked="" type="checkbox"/>
COPPER BRAID(FOR SCREEN)	<input checked="" type="checkbox"/>
CONSTANT FORCE SPRING(FOR SCREEN)	<input checked="" type="checkbox"/>
COPPER LUG(FOR COPPER BRAID)	<input type="checkbox"/>
TRIANGULAR WEDGE	<input type="checkbox"/>
COPPER BINDING-WIRE	<input checked="" type="checkbox"/>
STEEL ARMOUR RING	<input checked="" type="checkbox"/>
COPPER BRAID(FOR ARMOUR)	<input checked="" type="checkbox"/>
HOSE CLAMP	<input checked="" type="checkbox"/>
MEDICAL ADHESIVE TAPE	<input checked="" type="checkbox"/>
HEAT SHRINKABLE TUBING	<input checked="" type="checkbox"/>
WATERPROOFING SEALING MASTIC	<input checked="" type="checkbox"/>
HEAT SHRINKABLE INSULATION BREAKOUT	<input checked="" type="checkbox"/>
HEAT SHRINKABLE TRACK-RESISTANT TUBING(FOR INSULATING)	<input checked="" type="checkbox"/>
PHASE TUBING	<input checked="" type="checkbox"/>
PVC TAPE	<input type="checkbox"/>
EMERY CLOTH(400 MESHES)	<input type="checkbox"/>
EMERY CLOTH(185 MESHES)	<input type="checkbox"/>
CLEANING KIT	<input type="checkbox"/>
CLEANING CLOTH	<input type="checkbox"/>
PE GLOVES	<input type="checkbox"/>
UNDERSHIRT CLOTH GLOVES	<input type="checkbox"/>
INSTALLATION INSTRUCTION	<input checked="" type="checkbox"/>
PACKAGE LIST	<input checked="" type="checkbox"/>

Note: ■ The marked items are basically required.
 MELEC also provides customized set. Just tick on for your needs.
 Please consult MELEC sales for more details.

15kV Heat Shrinkable Termination Accessories

Application

MZDWK is an outdoor kit suitable for 3-core, steel wire armoured cables with copper tape screen.

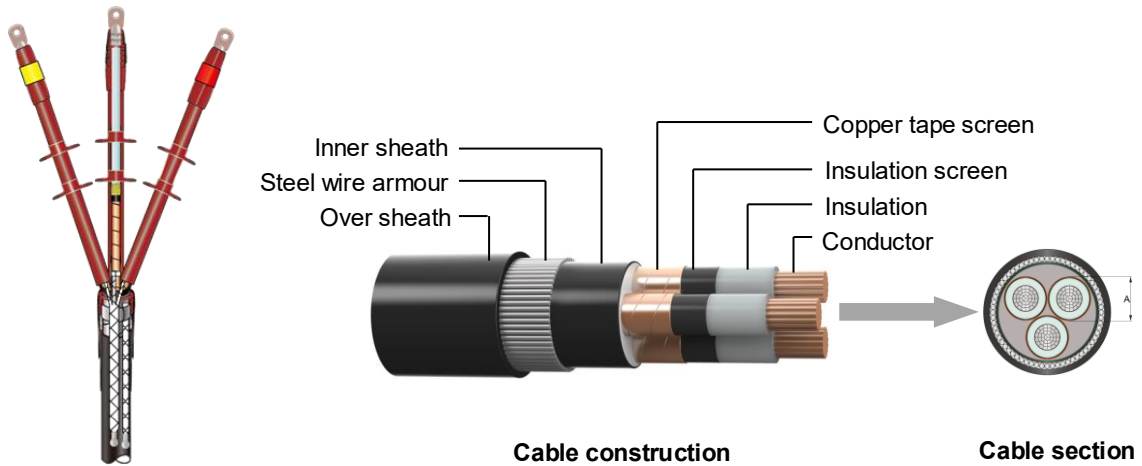

Cores	Type	Cross-section (mm ²)	Dia over Insulation A (mm)	Max. Dia over Lugs (mm)	Recommended Cable Lugs
 3-core	MZDWK-3-15-A/21	25-95	18.5~23.7	25.0	AU AUS CAL-BS CAL-BG CXAU DTL AUL
	MZDWK-3-15-B/21	35-150	19.5~26.7	28.0	
	MZDWK-3-15-C/21	70-240	22.1~30.5	34.5	
	MZDWK-3-15-D/21	120-300	25.1~32.7	40.0	
	MZDWK-3-15-E/21	185-400	28.3~35.6	42.0	
	MZDWK-3-15-F/21	500-630	38.8~43.2	52.0	

Note: Please consult MELEC sales for more details about cable lugs.

Standard Package List

Items	Selection
CABLE LUG	<input type="checkbox"/>
HEAT SHRINKABLE TRACK-RESISTANT TUBING(FOR SEALING)	<input checked="" type="checkbox"/>
STRESS CONTROL MASTIC(RHOMBUS)	<input checked="" type="checkbox"/>
SILICON GREASE	<input checked="" type="checkbox"/>
HEAT SHRINKABLE STRESS CONTROL TUBING	<input checked="" type="checkbox"/>
SEMI-CONDUCTIVE TAPE	<input checked="" type="checkbox"/>
COPPER BRAID(FOR SCREEN)	<input checked="" type="checkbox"/>
CONSTANT FORCE SPRING(FOR SCREEN)	<input checked="" type="checkbox"/>
COPPER LUG(FOR COPPER BRAID)	<input type="checkbox"/>
TRIANGULAR WEDGE	<input type="checkbox"/>
COPPER BINDING-WIRE	<input checked="" type="checkbox"/>
STEEL ARMOUR RING	<input checked="" type="checkbox"/>
COPPER BRAID(FOR ARMOUR)	<input checked="" type="checkbox"/>
HOSE CLAMP	<input checked="" type="checkbox"/>
MEDICAL ADHESIVE TAPE	<input checked="" type="checkbox"/>
HEAT SHRINKABLE TUBING	<input checked="" type="checkbox"/>
WATERPROOFING SEALING MASTIC	<input checked="" type="checkbox"/>
HEAT SHRINKABLE INSULATION BREAKOUT	<input checked="" type="checkbox"/>
HEAT SHRINKABLE TRACK-RESISTANT TUBING(FOR INSULATING)	<input checked="" type="checkbox"/>
PHASE TUBING	<input checked="" type="checkbox"/>
HEAT SHRINKABLE SKIRT	<input checked="" type="checkbox"/>
PVC TAPE	<input type="checkbox"/>
EMERY CLOTH(400 MESHES)	<input type="checkbox"/>
EMERY CLOTH(185 MESHES)	<input type="checkbox"/>
CLEANING KIT	<input type="checkbox"/>
CLEANING CLOTH	<input type="checkbox"/>
PE GLOVES	<input type="checkbox"/>
UNDERSHIRT CLOTH GLOVES	<input type="checkbox"/>
INSTALLATION INSTRUCTION	<input checked="" type="checkbox"/>
PACKAGE LIST	<input checked="" type="checkbox"/>

Note: ■ The marked items are basically required.
 MELEC also provides customized set. Just tick on for your needs.
 Please consult MELEC sales for more details.

15kV Heat Shrinkable Termination Accessories

Application

MZDNK is an indoor kit suitable for single core, steel wire armoured cables with copper tape screen.

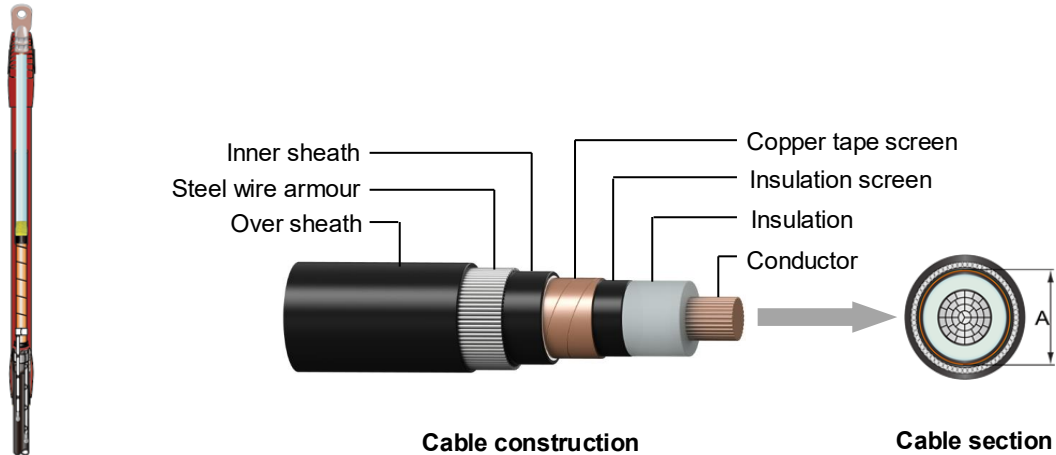

Cores	Type	Cross-section (mm ²)	Dia over Insulation A (mm)	Max. Dia over Lugs (mm)	Recommended Cable Lugs
 1-core	MZDNK-1-15-A/21	25-95	18.5~23.7	25.0	AU AUS CAL-BS CAL-BG CXAU DTLL AUL
	MZDNK-1-15-B/21	35-150	19.5~26.7	28.0	
	MZDNK-1-15-C/21	70-240	22.1~30.5	34.5	
	MZDNK-1-15-D/21	120-300	25.1~32.7	40.0	
	MZDNK-1-15-E/21	185-400	28.3~35.6	42.0	
	MZDNK-1-15-F/21	500-630	38.8~43.2	52.0	

Note: Please consult MELEC sales for more details about cable lugs.

Standard Package List

Items	Selection
CABLE LUG	<input type="checkbox"/>
HEAT SHRINKABLE TRACK-RESISTANT TUBING(FOR SEALING)	<input checked="" type="checkbox"/>
STRESS CONTROL MASTIC(RHOMBUS)	<input checked="" type="checkbox"/>
SILICON GREASE	<input checked="" type="checkbox"/>
HEAT SHRINKABLE STRESS CONTROL TUBING	<input checked="" type="checkbox"/>
SEMI-CONDUCTIVE TAPE	<input checked="" type="checkbox"/>
COPPER BRAID(FOR SCREEN)	<input checked="" type="checkbox"/>
COPPER LUG(FOR COPPER BRAID)	<input type="checkbox"/>
CONSTANT FORCE SPRING(FOR SCREEN)	<input checked="" type="checkbox"/>
COPPER BINDING-WIRE	<input checked="" type="checkbox"/>
COPPER BRAID(FOR ARMOUR)	<input checked="" type="checkbox"/>
HOSE CLAMP	<input checked="" type="checkbox"/>
MEDICAL ADHESIVE TAPE	<input checked="" type="checkbox"/>
HEAT SHRINKABLE TUBING	<input checked="" type="checkbox"/>
WATERPROOFING SEALING MASTIC	<input checked="" type="checkbox"/>
HEAT SHRINKABLE TRACK-RESISTANT TUBING(FOR INSULATING)	<input checked="" type="checkbox"/>
PVC TAPE	<input type="checkbox"/>
EMERY CLOTH(400 MESHES)	<input type="checkbox"/>
EMERY CLOTH(185 MESHES)	<input type="checkbox"/>
CLEANING KIT	<input type="checkbox"/>
CLEANING CLOTH	<input type="checkbox"/>
PE GLOVES	<input type="checkbox"/>
UNDERSHIRT CLOTH GLOVES	<input type="checkbox"/>
INSTALLATION INSTRUCTION	<input checked="" type="checkbox"/>
PACKAGE LIST	<input checked="" type="checkbox"/>

Note: ■ The marked items are basically required.
 MELEC also provides customized set. Just tick on for your needs.
 Please consult MELEC sales for more details.

15kV Heat Shrinkable Termination Accessories

Application

MZDWK is an outdoor kit suitable for single core, steel wire armoured cables with copper tape screen.

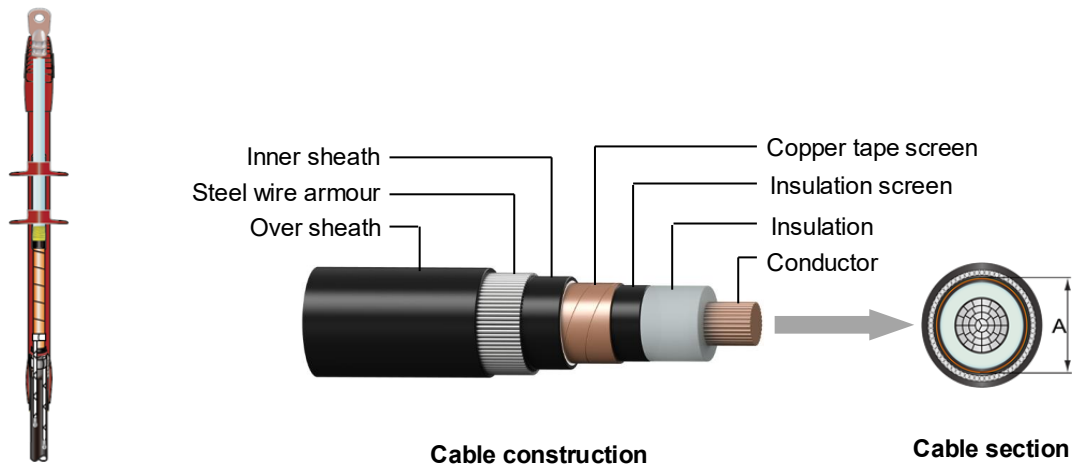

Cores	Type	Cross-section (mm ²)	Dia over Insulation A (mm)	Max. Dia over Lugs (mm)	Recommended Cable Lugs
 1-core	MZDWK-1-15-A/21	25-95	18.5~23.7	25.0	AU AUS CAL-BS CAL-BG CXAU DTLL AUL
	MZDWK-1-15-B/21	35-150	19.5~26.7	28.0	
	MZDWK-1-15-C/21	70-240	22.1~30.5	34.5	
	MZDWK-1-15-D/21	120-300	25.1~32.7	40.0	
	MZDWK-1-15-E/21	185-400	28.3~35.6	42.0	
	MZDWK-1-15-F/21	500-630	38.8~43.2	52.0	

Note: Please consult MELEC sales for more details about cable lugs.

Standard Package List

Items	Selection
CABLE LUG	<input type="checkbox"/>
HEAT SHRINKABLE TRACK-RESISTANT TUBING(FOR SEALING)	<input checked="" type="checkbox"/>
STRESS CONTROL MASTIC(RHOMBUS)	<input checked="" type="checkbox"/>
SILICON GREASE	<input checked="" type="checkbox"/>
HEAT SHRINKABLE STRESS CONTROL TUBING	<input checked="" type="checkbox"/>
SEMI-CONDUCTIVE TAPE	<input checked="" type="checkbox"/>
COPPER BRAID(FOR SCREEN)	<input checked="" type="checkbox"/>
COPPER LUG(FOR COPPER BRAID)	<input type="checkbox"/>
CONSTANT FORCE SPRING(FOR SCREEN)	<input checked="" type="checkbox"/>
COPPER BINDING-WIRE	<input checked="" type="checkbox"/>
COPPER BRAID(FOR ARMOUR)	<input checked="" type="checkbox"/>
HOSE CLAMP	<input checked="" type="checkbox"/>
MEDICAL ADHESIVE TAPE	<input checked="" type="checkbox"/>
HEAT SHRINKABLE TUBING	<input checked="" type="checkbox"/>
WATERPROOFING SEALING MASTIC	<input checked="" type="checkbox"/>
HEAT SHRINKABLE TRACK-RESISTANT TUBING(FOR INSULATING)	<input checked="" type="checkbox"/>
HEAT SHRINKABLE SKIRT	<input checked="" type="checkbox"/>
PVC TAPE	<input type="checkbox"/>
EMERY CLOTH(400 MESHES)	<input type="checkbox"/>
EMERY CLOTH(185 MESHES)	<input type="checkbox"/>
CLEANING KIT	<input type="checkbox"/>
CLEANING CLOTH	<input type="checkbox"/>
PE GLOVES	<input type="checkbox"/>
UNDERSHIRT CLOTH GLOVES	<input type="checkbox"/>
INSTALLATION INSTRUCTION	<input checked="" type="checkbox"/>
PACKAGE LIST	<input checked="" type="checkbox"/>

Note: ■ The marked items are basically required.
 MELEC also provides customized set. Just tick on for your needs.
 Please consult MELEC sales for more details.

15kV Heat Shrinkable Straight Joint Accessories

Application

MZJ is suitable for 3-core, unarmoured cables with copper tape screen. It can be used to repair cable connections in various occasions such as indoor, outdoor, underground and underwater.

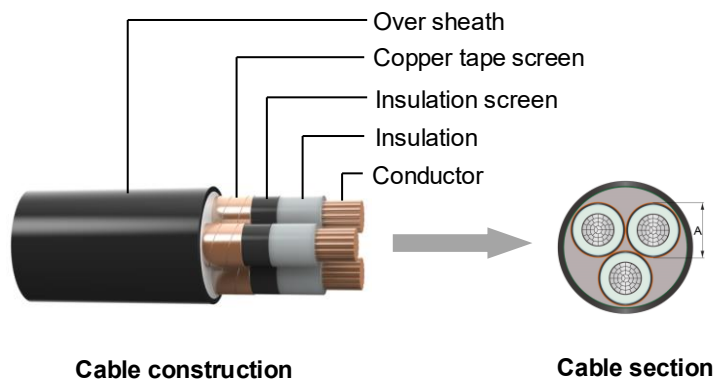

Cores	Type	Cross-section (mm ²)	Dia over Insulation A (mm)	Max. Dia over Connectors (mm)	Max. Length of Connector (mm)	Recommended Connectors
 3-core	MZJ-3-15-A/01	25-95	18.5~23.7	24.0	110	GLI GTD GLL
	MZJ-3-15-B/01	35-150	19.5~26.7	28.0	125	
	MZJ-3-15-C/01	70-240	22.1~30.5	33.0	145	
	MZJ-3-15-D/01	120-300	25.1~32.7	38.0	145	
	MZJ-3-15-E/01	185-400	28.3~35.6	42.0	210	
	MZJ-3-15-F/01	500-630	38.8~43.2	52.0	210	

Note: Please consult MELEC sales for more details about cable connectors.

Standard Package List

Items	Selection
CABLE CONNECTOR	<input type="checkbox"/>
STRESS CONTROL MASTIC(STRIP)	<input checked="" type="checkbox"/>
SILICON GREASE	<input checked="" type="checkbox"/>
STRESS CONTROL MASTIC(RHOMBUS)	<input checked="" type="checkbox"/>
HEAT SHRINKABLE STRESS CONTROL TUBING	<input checked="" type="checkbox"/>
HEAT SHRINKABLE TRACK-RESISTANT TUBING	<input checked="" type="checkbox"/>
HEAT SHRINKABLE INSULATION/SEMI-CONDUCTIVE TUBING	<input checked="" type="checkbox"/>
WATERPROOFING SEALING MASTIC	<input checked="" type="checkbox"/>
SEMI-CONDUCTIVE TAPE	<input checked="" type="checkbox"/>
TINNED SHIELDING COPPER NET	<input checked="" type="checkbox"/>
COPPER BRAID	<input checked="" type="checkbox"/>
CONSTANT FORCE SPRING	<input checked="" type="checkbox"/>
HEAT SHRINKABLE TUBING	<input checked="" type="checkbox"/>
PVC TAPE	<input type="checkbox"/>
EMERY CLOTH(400 MESHES)	<input type="checkbox"/>
EMERY CLOTH(185 MESHES)	<input type="checkbox"/>
CLEANING KIT	<input type="checkbox"/>
CLEANING CLOTH	<input type="checkbox"/>
PE GLOVES	<input type="checkbox"/>
UNDERSHIRT CLOTH GLOVES	<input type="checkbox"/>
INSTALLATION INSTRUCTION	<input checked="" type="checkbox"/>
PACKAGE LIST	<input checked="" type="checkbox"/>

Note: ■ The marked items are basically required.
 MELEC also provides customized set. Just tick on for your needs.
 Please consult MELEC sales for more details.

15kV Heat Shrinkable Straight Joint Accessories

Application

MZJ is suitable for single core, unarmoured cables with copper tape screen. It can be used to repair cable connections in various occasions such as indoor, outdoor, underground and underwater.

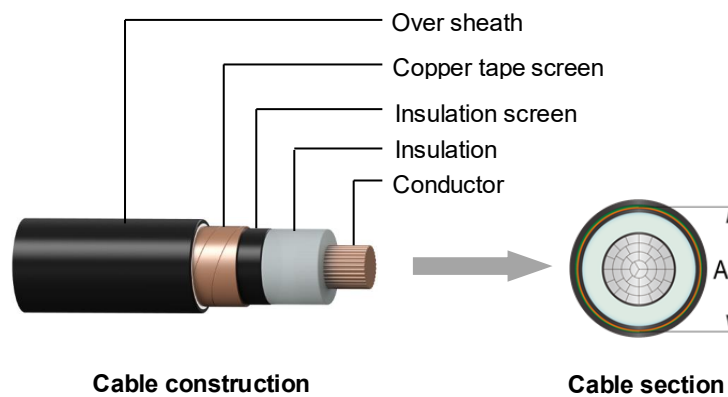

Cores	Type	Cross-section (mm ²)	Dia over Insulation A (mm)	Max. Dia over Connectors (mm)	Max. Length of Connector (mm)	Recommended Connectors
 1-core	MZJ-1-15-A/01	25-95	18.5~23.7	24.0	110	GLI GTD GLL
	MZJ-1-15-B/01	35-150	19.5~26.7	28.0	125	
	MZJ-1-15-C/01	70-240	22.1~30.5	33.0	145	
	MZJ-1-15-D/01	120-300	25.1~32.7	38.0	145	
	MZJ-1-15-E/01	185-400	28.3~35.6	42.0	210	
	MZJ-1-15-F/01	500-630	38.8~43.2	52.0	210	

Note: Please consult MELEC sales for more details about cable connectors.

Standard Package List

Items	Selection
CABLE CONNECTOR	<input type="checkbox"/>
STRESS CONTROL MASTIC(STRIP)	<input checked="" type="checkbox"/>
SILICON GREASE	<input checked="" type="checkbox"/>
STRESS CONTROL MASTIC(RHOMBUS)	<input checked="" type="checkbox"/>
HEAT SHRINKABLE STRESS CONTROL TUBING	<input checked="" type="checkbox"/>
HEAT SHRINKABLE TRACK-RESISTANT TUBING	<input checked="" type="checkbox"/>
HEAT SHRINKABLE INSULATION/SEMI-CONDUCTIVE TUBING	<input checked="" type="checkbox"/>
WATERPROOFING SEALING MASTIC	<input checked="" type="checkbox"/>
SEMI-CONDUCTIVE TAPE	<input checked="" type="checkbox"/>
TINNED SHIELDING COPPER NET	<input checked="" type="checkbox"/>
COPPER BRAID	<input checked="" type="checkbox"/>
CONSTANT FORCE SPRING	<input checked="" type="checkbox"/>
HEAT SHRINKABLE TUBING	<input checked="" type="checkbox"/>
PVC TAPE	<input type="checkbox"/>
EMERY CLOTH(400 MESHES)	<input type="checkbox"/>
EMERY CLOTH(185 MESHES)	<input type="checkbox"/>
CLEANING KIT	<input type="checkbox"/>
CLEANING CLOTH	<input type="checkbox"/>
PE GLOVES	<input type="checkbox"/>
UNDERSHIRT CLOTH GLOVES	<input type="checkbox"/>
INSTALLATION INSTRUCTION	<input checked="" type="checkbox"/>
PACKAGE LIST	<input checked="" type="checkbox"/>

Note: ■ The marked items are basically required.
 MELEC also provides customized set. Just tick on for your needs.
 Please consult MELEC sales for more details.

15kV Heat Shrinkable Straight Joint Accessories

Application

MZJ is suitable for 3-core, unarmoured cables with copper wire screen. It can be used to repair cable connections in various occasions such as indoor, outdoor, underground and underwater.

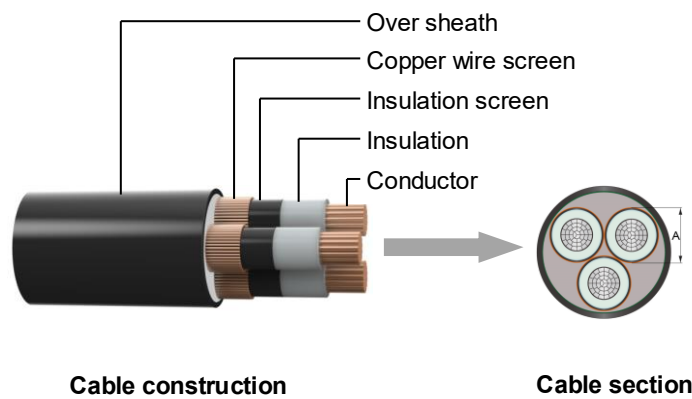

Cores	Type	Cross-section (mm ²)	Dia over Insulation A (mm)	Max. Dia over Connectors (mm)	Max. Length of Connector (mm)	Recommended Connectors
 3-core	MZJ-3-15-A/02	25-95	18.5~23.7	24.0	110	GLI GTD GLL
	MZJ-3-15-B/02	35-150	19.5~26.7	28.0	125	
	MZJ-3-15-C/02	70-240	22.1~30.5	33.0	145	
	MZJ-3-15-D/02	120-300	25.1~32.7	38.0	145	
	MZJ-3-15-E/02	185-400	28.3~35.6	42.0	210	
	MZJ-3-15-F/02	500-630	38.8~43.2	52.0	210	

Note: Please consult MELEC sales for more details about cable connectors.

Standard Package List

Items	Selection
CABLE CONNECTOR	<input type="checkbox"/>
STRESS CONTROL MASTIC(STRIP)	<input checked="" type="checkbox"/>
SILICON GREASE	<input checked="" type="checkbox"/>
STRESS CONTROL MASTIC(RHOMBUS)	<input checked="" type="checkbox"/>
HEAT SHRINKABLE STRESS CONTROL TUBING	<input checked="" type="checkbox"/>
HEAT SHRINKABLE TRACK-RESISTANT TUBING	<input checked="" type="checkbox"/>
HEAT SHRINKABLE INSULATION/SEMI-CONDUCTIVE TUBING	<input checked="" type="checkbox"/>
WATERPROOFING SEALING MASTIC	<input checked="" type="checkbox"/>
TINNED SHIELDING COPPER NET	<input checked="" type="checkbox"/>
CONSTANT FORCE SPRING	<input checked="" type="checkbox"/>
COPPER CONNECTOR(FOR COPPER WIRE SCREEN)	<input checked="" type="checkbox"/>
HEAT SHRINKABLE TUBING	<input checked="" type="checkbox"/>
PVC TAPE	<input type="checkbox"/>
EMERY CLOTH(400 MESHES)	<input type="checkbox"/>
EMERY CLOTH(185 MESHES)	<input type="checkbox"/>
CLEANING KIT	<input type="checkbox"/>
CLEANING CLOTH	<input type="checkbox"/>
PE GLOVES	<input type="checkbox"/>
UNDERSHIRT CLOTH GLOVES	<input type="checkbox"/>
INSTALLATION INSTRUCTION	<input checked="" type="checkbox"/>
PACKAGE LIST	<input checked="" type="checkbox"/>

Note: ■ The marked items are basically required.

- MELEC also provides customized set. Just tick on for your needs.
Please consult MELEC sales for more details.

15kV Heat Shrinkable Straight Joint Accessories

Application

MZJ is suitable for single core, unarmoured cables with copper wire screen. It can be used to repair cable connections in various occasions such as indoor, outdoor, underground and underwater.

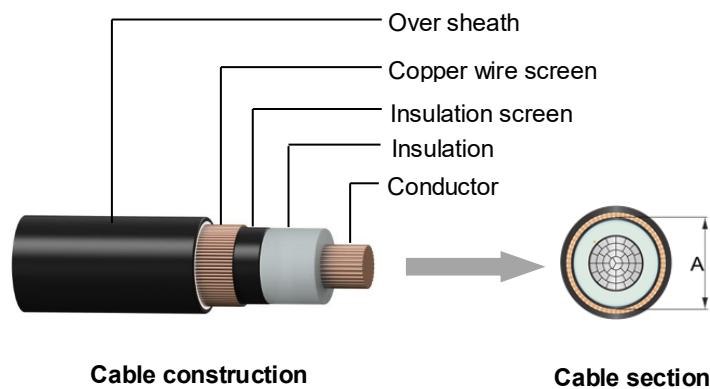

Cores	Type	Cross-section (mm ²)	Dia over Insulation A (mm)	Max. Dia over Connectors (mm)	Max. Length of Connector (mm)	Recommended Connectors
 1-core	MZJ-1-15-A/02	25-95	18.5~23.7	24.0	110	GLI GTD GLL
	MZJ-1-15-B/02	35-150	19.5~26.7	28.0	125	
	MZJ-1-15-C/02	70-240	22.1~30.5	33.0	145	
	MZJ-1-15-D/02	120-300	25.1~32.7	38.0	145	
	MZJ-1-15-E/02	185-400	28.3~35.6	42.0	210	
	MZJ-1-15-F/02	500-630	38.8~43.2	52.0	210	

Note: Please consult MELEC sales for more details about cable connectors.

Standard Package List

Items	Selection
CABLE CONNECTOR	<input type="checkbox"/>
STRESS CONTROL MASTIC(STRIP)	<input checked="" type="checkbox"/>
SILICON GREASE	<input checked="" type="checkbox"/>
STRESS CONTROL MASTIC(RHOMBUS)	<input checked="" type="checkbox"/>
HEAT SHRINKABLE STRESS CONTROL TUBING	<input checked="" type="checkbox"/>
HEAT SHRINKABLE TRACK-RESISTANT TUBING	<input checked="" type="checkbox"/>
HEAT SHRINKABLE INSULATION/SEMI-CONDUCTIVE TUBING	<input checked="" type="checkbox"/>
WATERPROOFING SEALING MASTIC	<input checked="" type="checkbox"/>
TINNED SHIELDING COPPER NET	<input checked="" type="checkbox"/>
COPPER BRAID	<input checked="" type="checkbox"/>
COPPER CONNECTOR(FOR COPPER WIRE SCREEN)	<input checked="" type="checkbox"/>
CONSTANT FORCE SPRING	<input checked="" type="checkbox"/>
HEAT SHRINKABLE TUBING	<input checked="" type="checkbox"/>
PVC TAPE	<input type="checkbox"/>
EMERY CLOTH(400 MESHES)	<input type="checkbox"/>
EMERY CLOTH(185 MESHES)	<input type="checkbox"/>
CLEANING KIT	<input type="checkbox"/>
CLEANING CLOTH	<input type="checkbox"/>
PE GLOVES	<input type="checkbox"/>
UNDERSHIRT CLOTH GLOVES	<input type="checkbox"/>
INSTALLATION INSTRUCTION	<input checked="" type="checkbox"/>
PACKAGE LIST	<input checked="" type="checkbox"/>

Note: ■ The marked items are basically required.
 MELEC also provides customized set. Just tick on for your needs.
 Please consult MELEC sales for more details.

15kV Heat Shrinkable Straight Joint Accessories

Application

MZJK is suitable for 3-core, steel tape armoured cables with copper tape screen. It can be used to repair cable connections in various occasions such as indoor, outdoor, underground and underwater.

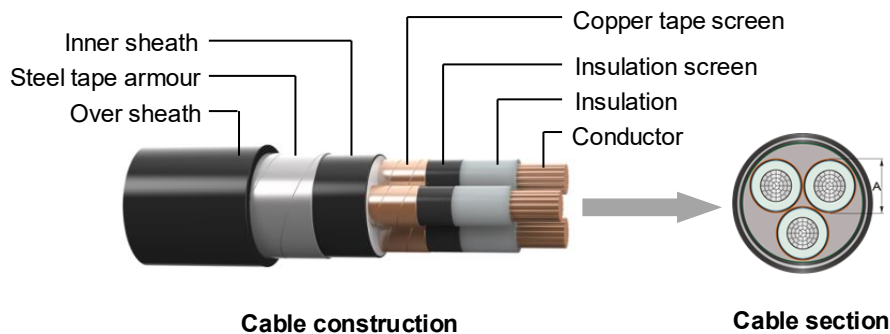
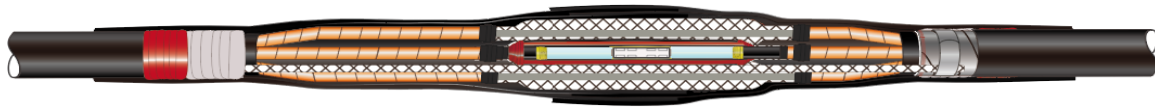

Cores	Type	Cross-section (mm ²)	Dia over Insulation A (mm)	Max. Dia over Connectors (mm)	Max. Length of Connector (mm)	Recommended Connectors
 3-core	MZJK-3-15-A/11	25-95	18.5~23.7	24.0	110	GLI GTD GLL
	MZJK-3-15-B/11	35-150	19.5~26.7	28.0	125	
	MZJK-3-15-C/11	70-240	22.1~30.5	33.0	145	
	MZJK-3-15-D/11	120-300	25.1~32.7	38.0	145	
	MZJK-3-15-E/11	185-400	28.3~35.6	42.0	210	
	MZJK-3-15-F/11	500-630	38.8~43.2	52.0	210	

Note: Please consult MELEC sales for more details about cable connectors.

Standard Package List

Items	Selection
CABLE CONNECTOR	<input type="checkbox"/>
STRESS CONTROL MASTIC(STRIP)	<input checked="" type="checkbox"/>
SILICON GREASE	<input checked="" type="checkbox"/>
STRESS CONTROL MASTIC(RHOMBUS)	<input checked="" type="checkbox"/>
HEAT SHRINKABLE STRESS CONTROL TUBING	<input checked="" type="checkbox"/>
HEAT SHRINKABLE TRACK-RESISTANT TUBING	<input checked="" type="checkbox"/>
HEAT SHRINKABLE INSULATION/SEMI-CONDUCTIVE TUBING	<input checked="" type="checkbox"/>
WATERPROOFING SEALING MASTIC	<input checked="" type="checkbox"/>
SEMI-CONDUCTIVE TAPE	<input checked="" type="checkbox"/>
TINNED SHIELDING COPPER NET	<input checked="" type="checkbox"/>
COPPER BRAID(FOR SCREEN)	<input checked="" type="checkbox"/>
CONSTANT FORCE SPRING(FOR SCREEN)	<input checked="" type="checkbox"/>
HEAT SHRINKABLE TUBING(FOR INNER SHEATH)	<input checked="" type="checkbox"/>
COPPER BINDING-WIRE	<input checked="" type="checkbox"/>
COPPER BRAID(FOR ARMOUR)	<input checked="" type="checkbox"/>
CONSTANT FORCE SPRING(FOR ARMOUR)	<input checked="" type="checkbox"/>
FILLING MASTIC	<input checked="" type="checkbox"/>
HEAT SHRINKABLE TUBING(FOR OVER SHEATH)	<input checked="" type="checkbox"/>
PVC TAPE	<input type="checkbox"/>
EMERY CLOTH(400 MESHES)	<input type="checkbox"/>
EMERY CLOTH(185 MESHES)	<input type="checkbox"/>
CLEANING KIT	<input type="checkbox"/>
CLEANING CLOTH	<input type="checkbox"/>
PE GLOVES	<input type="checkbox"/>
UNDERSHIRT CLOTH GLOVES	<input type="checkbox"/>
INSTALLATION INSTRUCTION	<input checked="" type="checkbox"/>
PACKAGE LIST	<input checked="" type="checkbox"/>

Note: ■ The marked items are basically required.
 MELEC also provides customized set. Just tick on for your needs.
 Please consult MELEC sales for more details.

15kV Heat Shrinkable Straight Joint Accessories

Application

MZJK is suitable for single core, steel tape armoured cables with copper tape screen. It can be used to repair cable connections in various occasions such as indoor, outdoor, underground and underwater.

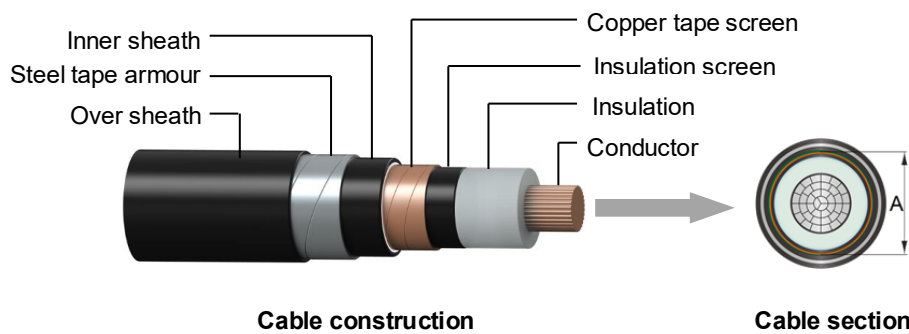
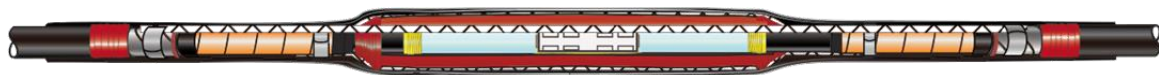

Cores	Type	Cross-section (mm ²)	Dia over Insulation A (mm)	Max. Dia over Connectors (mm)	Max. Length of Connector (mm)	Recommended Connectors
 1-core	MZJK-1-15-A/11	25-95	18.5~23.7	24.0	110	GLI GTD GLL
	MZJK-1-15-B/11	35-150	19.5~26.7	28.0	125	
	MZJK-1-15-C/11	70-240	22.1~30.5	33.0	145	
	MZJK-1-15-D/11	120-300	25.1~32.7	38.0	145	
	MZJK-1-15-E/11	185-400	28.3~35.6	42.0	210	
	MZJK-1-15-F/11	500-630	38.8~43.2	52.0	210	

Note: Please consult MELEC sales for more details about cable connectors.

Standard Package List

Items	Selection
CABLE CONNECTOR	<input type="checkbox"/>
STRESS CONTROL MASTIC(STRIP)	<input checked="" type="checkbox"/>
SILICON GREASE	<input checked="" type="checkbox"/>
STRESS CONTROL MASTIC(RHOMBUS)	<input checked="" type="checkbox"/>
HEAT SHRINKABLE STRESS CONTROL TUBING	<input checked="" type="checkbox"/>
HEAT SHRINKABLE TRACK-RESISTANT TUBING	<input checked="" type="checkbox"/>
HEAT SHRINKABLE INSULATION/SEMI-CONDUCTIVE TUBING	<input checked="" type="checkbox"/>
WATERPROOFING SEALING MASTIC	<input checked="" type="checkbox"/>
SEMI-CONDUCTIVE TAPE	<input checked="" type="checkbox"/>
TINNED SHIELDING COPPER NET	<input checked="" type="checkbox"/>
COPPER BRAID(FOR SCREEN)	<input checked="" type="checkbox"/>
CONSTANT FORCE SPRING(FOR SCREEN)	<input checked="" type="checkbox"/>
HEAT SHRINKABLE TUBING(FOR INNER SHEATH)	<input checked="" type="checkbox"/>
COPPER BINDING-WIRE	<input checked="" type="checkbox"/>
COPPER BRAID(FOR ARMOUR)	<input checked="" type="checkbox"/>
CONSTANT FORCE SPRING(FOR ARMOUR)	<input checked="" type="checkbox"/>
FILLING MASTIC	<input checked="" type="checkbox"/>
HEAT SHRINKABLE TUBING(FOR OVER SHEATH)	<input checked="" type="checkbox"/>
PVC TAPE	<input type="checkbox"/>
EMERY CLOTH(400 MESHES)	<input type="checkbox"/>
EMERY CLOTH(185 MESHES)	<input type="checkbox"/>
CLEANING KIT	<input type="checkbox"/>
CLEANING CLOTH	<input type="checkbox"/>
PE GLOVES	<input type="checkbox"/>
UNDERSHIRT CLOTH GLOVES	<input type="checkbox"/>
INSTALLATION INSTRUCTION	<input checked="" type="checkbox"/>
PACKAGE LIST	<input checked="" type="checkbox"/>

Note: ■ The marked items are basically required.
 MELEC also provides customized set. Just tick on for your needs.
 Please consult MELEC sales for more details.

15kV Heat Shrinkable Straight Joint Accessories

Application

MZJK is suitable for 3-core, steel wire armoured cables with copper tape screen. It can be used to repair cable connections in various occasions such as indoor, outdoor, underground and underwater.

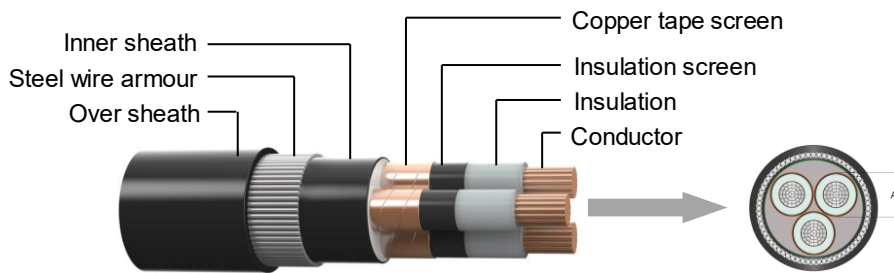

Cable construction

Cable section

Cores	Type	Cross-section (mm ²)	Dia over Insulation A (mm)	Max. Dia over Connectors (mm)	Max. Length of Connector (mm)	Recommended Connectors
 3-core	MZJK-3-15-A/21	25-95	18.5~23.7	24.0	110	GLI GTD GLL
	MZJK-3-15-B/21	35-150	19.5~26.7	28.0	125	
	MZJK-3-15-C/21	70-240	22.1~30.5	33.0	145	
	MZJK-3-15-D/21	120-300	25.1~32.7	38.0	145	
	MZJK-3-15-E/21	185-400	28.3~35.6	42.0	210	
	MZJK-3-15-F/21	500-630	38.8~43.2	52.0	210	

Note: Please consult MELEC sales for more details about cable connectors.

Standard Package List

Items	Selection
CABLE CONNECTOR	<input type="checkbox"/>
STRESS CONTROL MASTIC(STRIP)	<input checked="" type="checkbox"/>
SILICON GREASE	<input checked="" type="checkbox"/>
STRESS CONTROL MASTIC(RHOMBUS)	<input checked="" type="checkbox"/>
HEAT SHRINKABLE STRESS CONTROL TUBING	<input checked="" type="checkbox"/>
HEAT SHRINKABLE TRACK-RESISTANT TUBING	<input checked="" type="checkbox"/>
HEAT SHRINKABLE INSULATION/SEMI-CONDUCTIVE TUBING	<input checked="" type="checkbox"/>
WATERPROOFING SEALING MASTIC	<input checked="" type="checkbox"/>
SEMI-CONDUCTIVE TAPE	<input checked="" type="checkbox"/>
TINNED SHIELDING COPPER NET	<input checked="" type="checkbox"/>
COPPER BRAID(FOR SCREEN)	<input checked="" type="checkbox"/>
CONSTANT FORCE SPRING(FOR SCREEN)	<input checked="" type="checkbox"/>
HEAT SHRINKABLE TUBING(FOR INNER SHEATH)	<input checked="" type="checkbox"/>
COPPER BINDING-WIRE	<input checked="" type="checkbox"/>
STEEL ARMOUR RING	<input checked="" type="checkbox"/>
COPPER BRAID(FOR ARMOUR)	<input checked="" type="checkbox"/>
STEEL ARMOUR CASE	<input checked="" type="checkbox"/>
HOSE CLAMP	<input checked="" type="checkbox"/>
MEDICAL ADHESIVE TAPE	<input checked="" type="checkbox"/>
HEAT SHRINKABLE TUBING(FOR OVER SHEATH)	<input checked="" type="checkbox"/>
PVC TAPE	<input type="checkbox"/>
EMERY CLOTH(400 MESHES)	<input type="checkbox"/>
EMERY CLOTH(185 MESHES)	<input type="checkbox"/>
CLEANING KIT	<input type="checkbox"/>
CLEANING CLOTH	<input type="checkbox"/>
PE GLOVES	<input type="checkbox"/>
UNDERSHIRT CLOTH GLOVES	<input type="checkbox"/>
INSTALLATION INSTRUCTION	<input checked="" type="checkbox"/>
PACKAGE LIST	<input checked="" type="checkbox"/>

Note: ■ The marked items are basically required.
 MELEC also provides customized set. Just tick on for your needs.
 Please consult MELEC sales for more details.

15kV Heat Shrinkable Straight Joint Accessories

Application

MZJK is suitable for single core, steel wire armoured cables with copper tape screen. It can be used to repair cable connections in various occasions such as indoor, outdoor, underground and underwater.

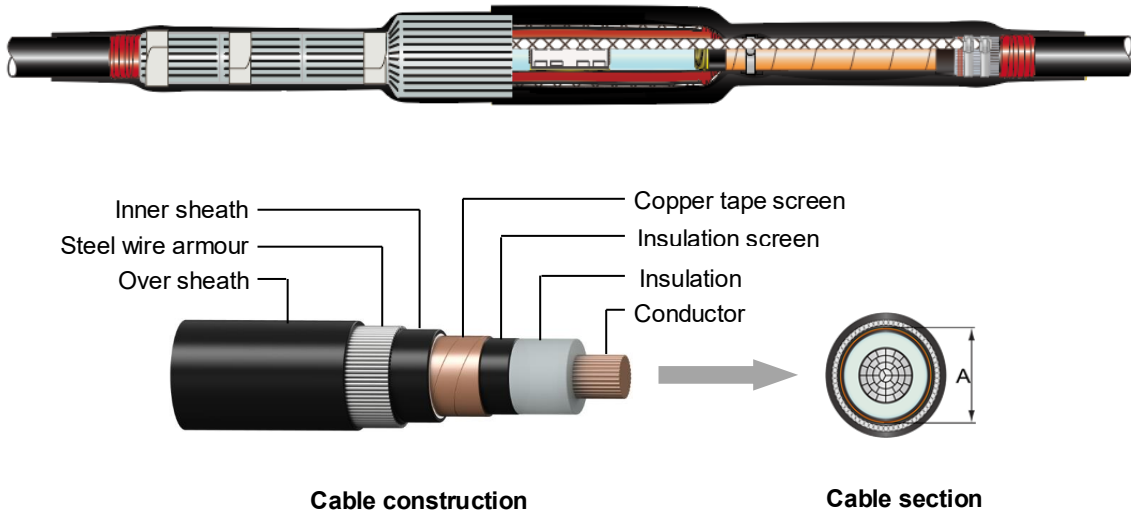

Cores	Type	Cross-section (mm ²)	Dia over Insulation A (mm)	Max. Dia over Connectors (mm)	Max. Length of Connector (mm)	Recommended Connectors
 1-core	MZJK-1-15-A/21	25-95	18.5~23.7	24.0	110	GLI GTD GLL
	MZJK-1-15-B/21	35-150	19.5~26.7	28.0	125	
	MZJK-1-15-C/21	70-240	22.1~30.5	33.0	145	
	MZJK-1-15-D/21	120-300	25.1~32.7	38.0	145	
	MZJK-1-15-E/21	185-400	28.3~35.6	42.0	210	
	MZJK-1-15-F/21	500-630	38.8~43.2	52.0	210	

Note: Please consult MELEC sales for more details about cable connectors.

Standard Package List

Items	Selection
CABLE CONNECTOR	<input type="checkbox"/>
STRESS CONTROL MASTIC(STRIP)	<input checked="" type="checkbox"/>
SILICON GREASE	<input checked="" type="checkbox"/>
STRESS CONTROL MASTIC(RHOMBUS)	<input checked="" type="checkbox"/>
HEAT SHRINKABLE STRESS CONTROL TUBING	<input checked="" type="checkbox"/>
HEAT SHRINKABLE TRACK-RESISTANT TUBING	<input checked="" type="checkbox"/>
HEAT SHRINKABLE INSULATION/SEMI-CONDUCTIVE TUBING	<input checked="" type="checkbox"/>
WATERPROOFING SEALING MASTIC	<input checked="" type="checkbox"/>
SEMI-CONDUCTIVE TAPE	<input checked="" type="checkbox"/>
TINNED SHIELDING COPPER NET	<input checked="" type="checkbox"/>
COPPER BRAID(FOR SCREEN)	<input checked="" type="checkbox"/>
CONSTANT FORCE SPRING(FOR SCREEN)	<input checked="" type="checkbox"/>
HEAT SHRINKABLE TUBING(FOR INNER SHEATH)	<input checked="" type="checkbox"/>
COPPER BINDING-WIRE	<input checked="" type="checkbox"/>
COPPER BRAID(FOR ARMOUR)	<input checked="" type="checkbox"/>
STEEL ARMOUR CASE	<input checked="" type="checkbox"/>
HOSE CLAMP	<input checked="" type="checkbox"/>
MEDICAL ADHESIVE TAPE	<input checked="" type="checkbox"/>
HEAT SHRINKABLE TUBING(FOR OVER SHEATH)	<input checked="" type="checkbox"/>
PVC TAPE	<input type="checkbox"/>
EMERY CLOTH(400 MESHES)	<input type="checkbox"/>
EMERY CLOTH(185 MESHES)	<input type="checkbox"/>
CLEANING KIT	<input type="checkbox"/>
CLEANING CLOTH	<input type="checkbox"/>
PE GLOVES	<input type="checkbox"/>
UNDERSHIRT CLOTH GLOVES	<input type="checkbox"/>
INSTALLATION INSTRUCTION	<input checked="" type="checkbox"/>
PACKAGE LIST	<input checked="" type="checkbox"/>

Note: ■ The marked items are basically required.

- MELEC also provides customized set. Just tick on for your needs.
Please consult MELEC sales for more details.